

Clásica series

Acabados / Finishes :

01	oro / <i>gold plated</i>	43	satinado oro viejo / <i>satín old gold</i>
12	baño oro patina negra / <i>gold plated and black patine</i>	44	latón antiguo mate / <i>mat antique brass</i>
30	latón antiguo / <i>antique brass</i>	45	bronce inglés mate / <i>english bronze</i>
34	brillo satinado patina negra / <i>satined brass and black patined</i>	62	níquel satinado / <i>satín nickel</i>
		71	plata óxida / <i>antique silver</i>
		72	cobre óxido / <i>oxid copper</i>

En la tarifa de precios puede ver los diferentes acabados en los que se ofrece cada artículo de esta serie.

You can find in the price list the different finishes that we offer for each item of this series.



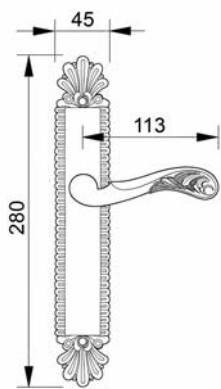

0A2660.85Y.12

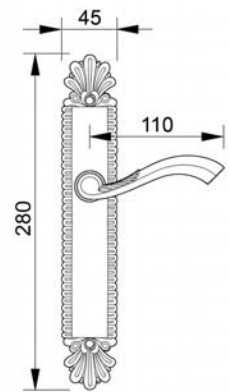
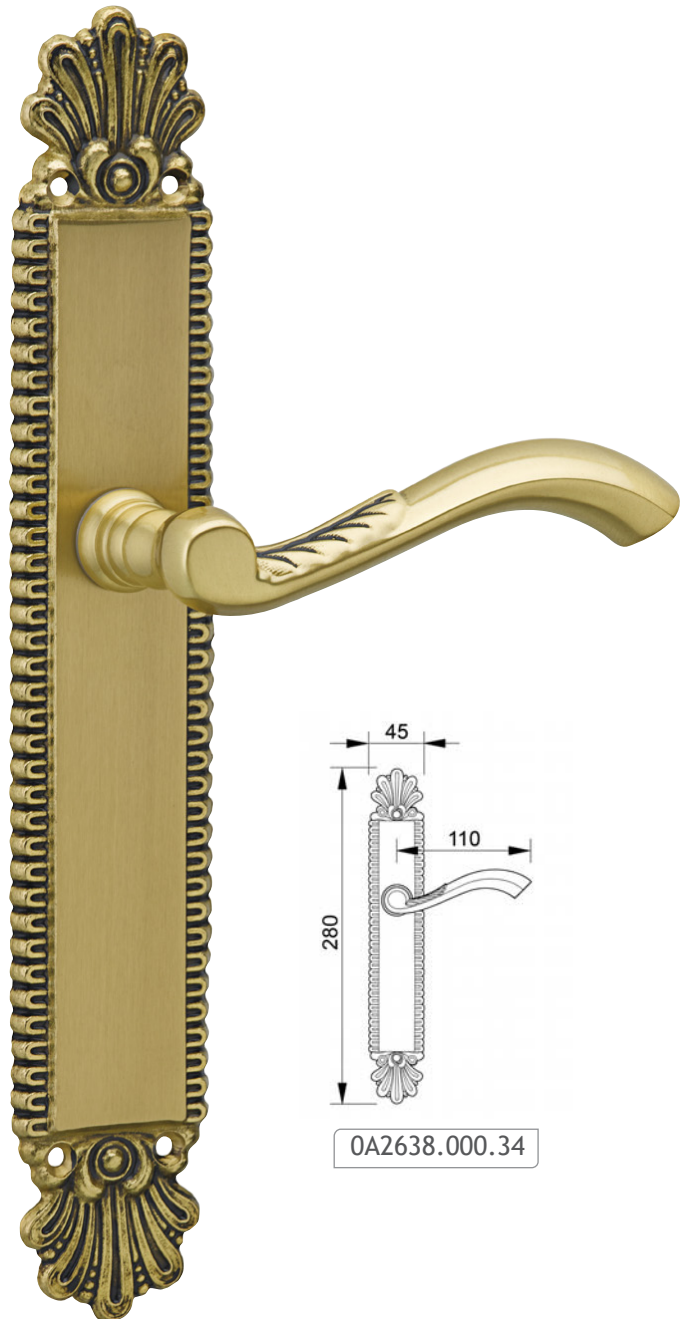

0A2638.000.34

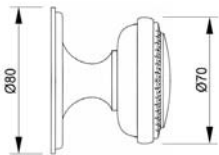

OC2616.000.34

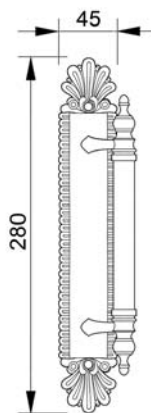

OM2602.000.34



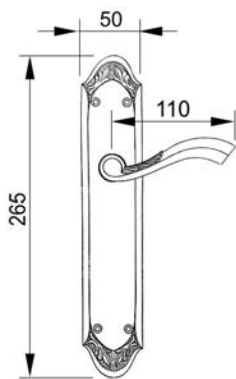

0A1438.000.12

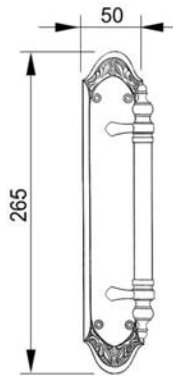

0M1403.000.45



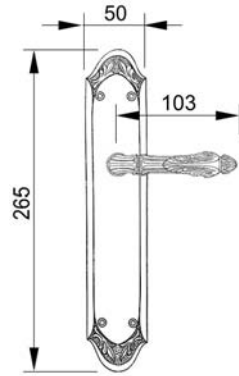

0A1436.000.01

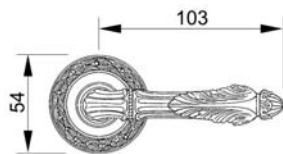

0R6536.000.44

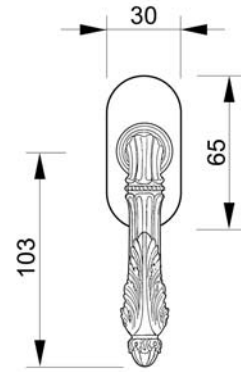

OV0736.000.44

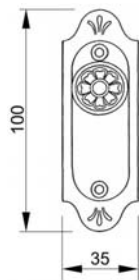

OT1408.000.45

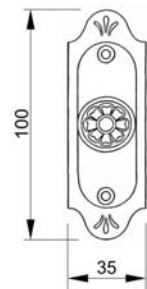

OT1409.000.45

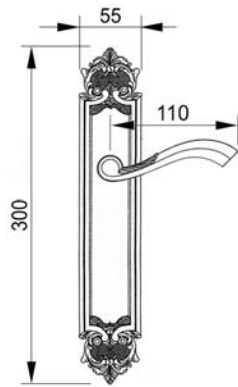

0A3800.000.34

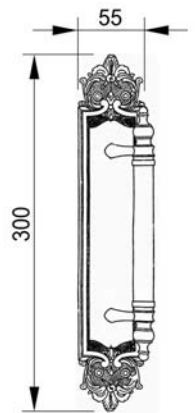

0M3802.000.34

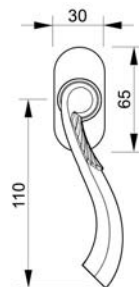
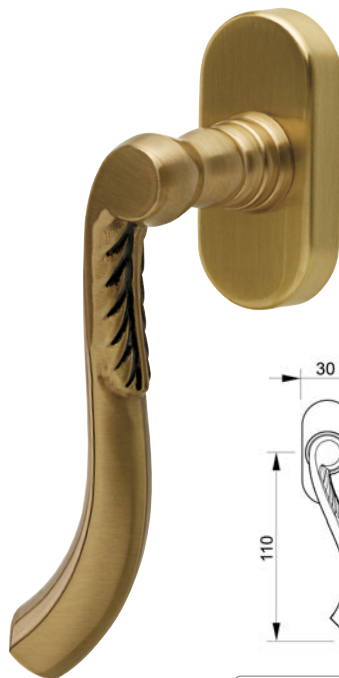

0V0738.D00.34

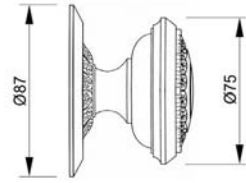

OC3816.000.34

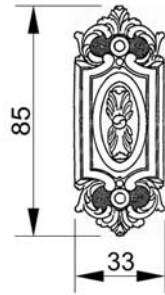

OT3809.000.34

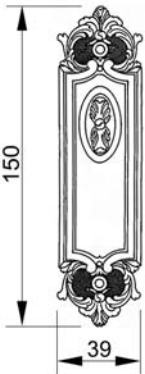

OT3808.000.34

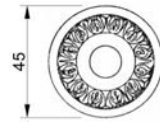

OX3822.15M.34

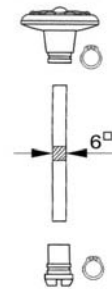

OS3881.000.01

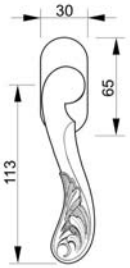

OV0760.D00.01

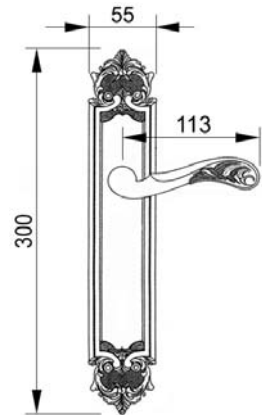
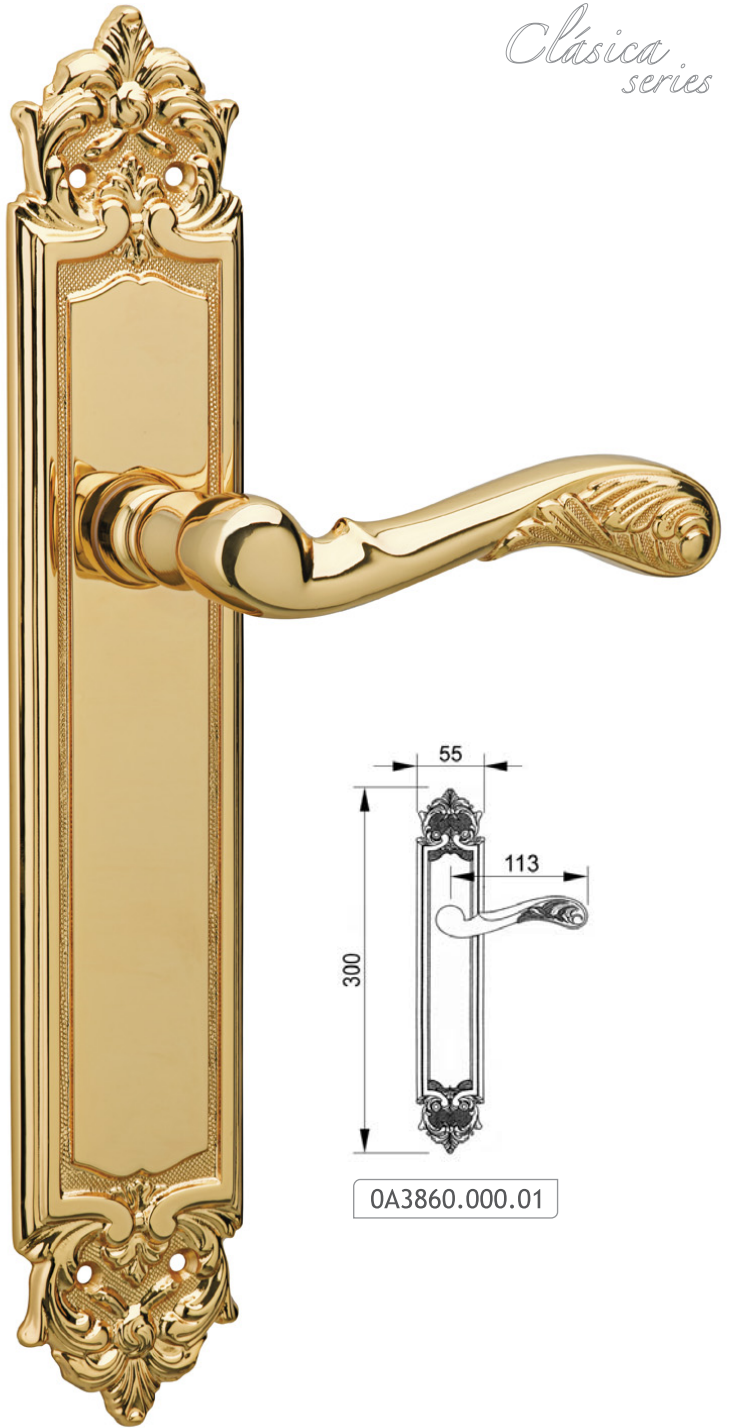

0A3860.000.01

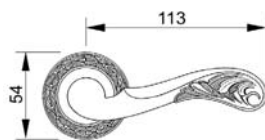

OR6560.000.44

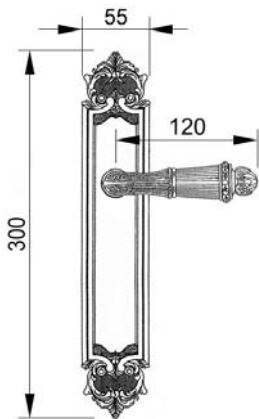

0A3870.000.01

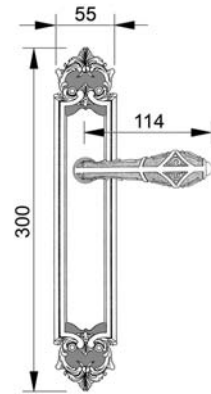

0A3834.000.12

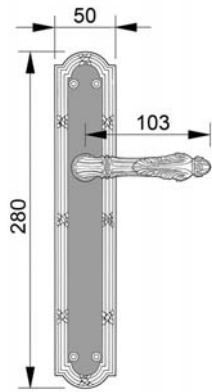
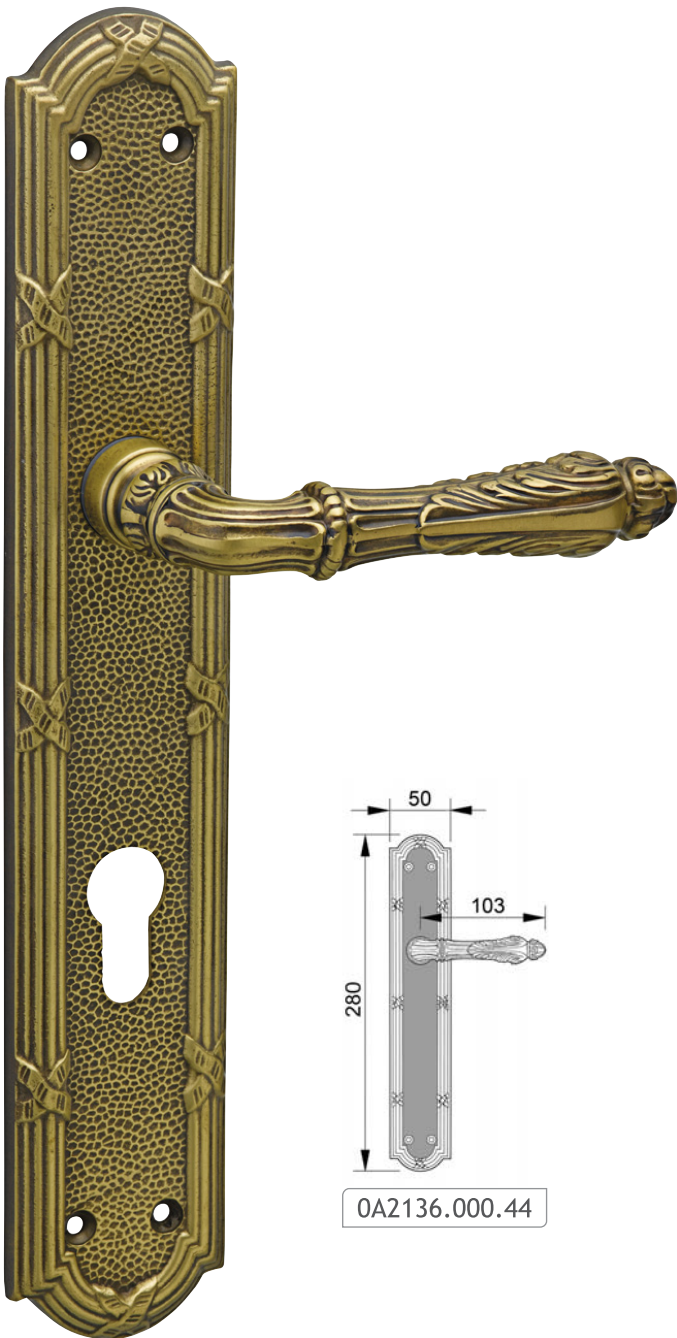

0A2136.000.44

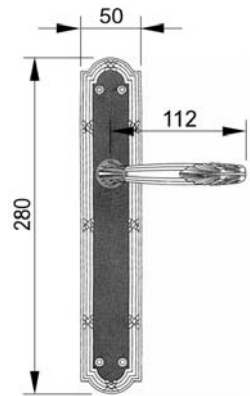

0A2150.000.30

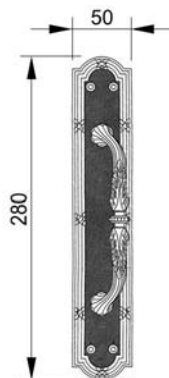

0M2102.000.30

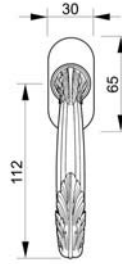
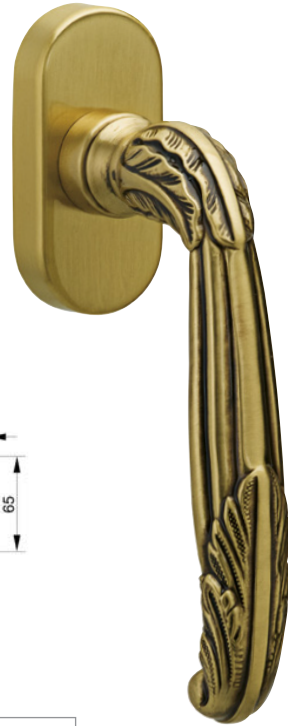

0V0721.000.30

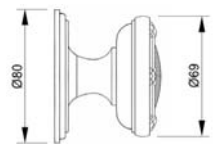

0C2116.000.01

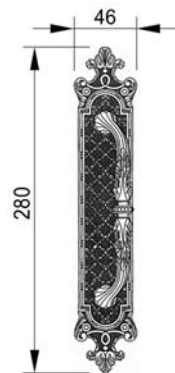

0M3602.000.30



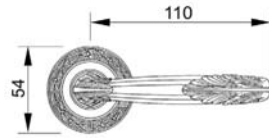

0R6521.000.01

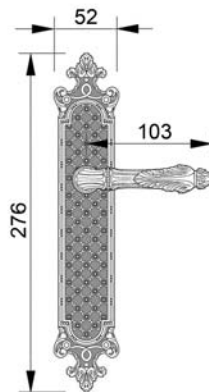
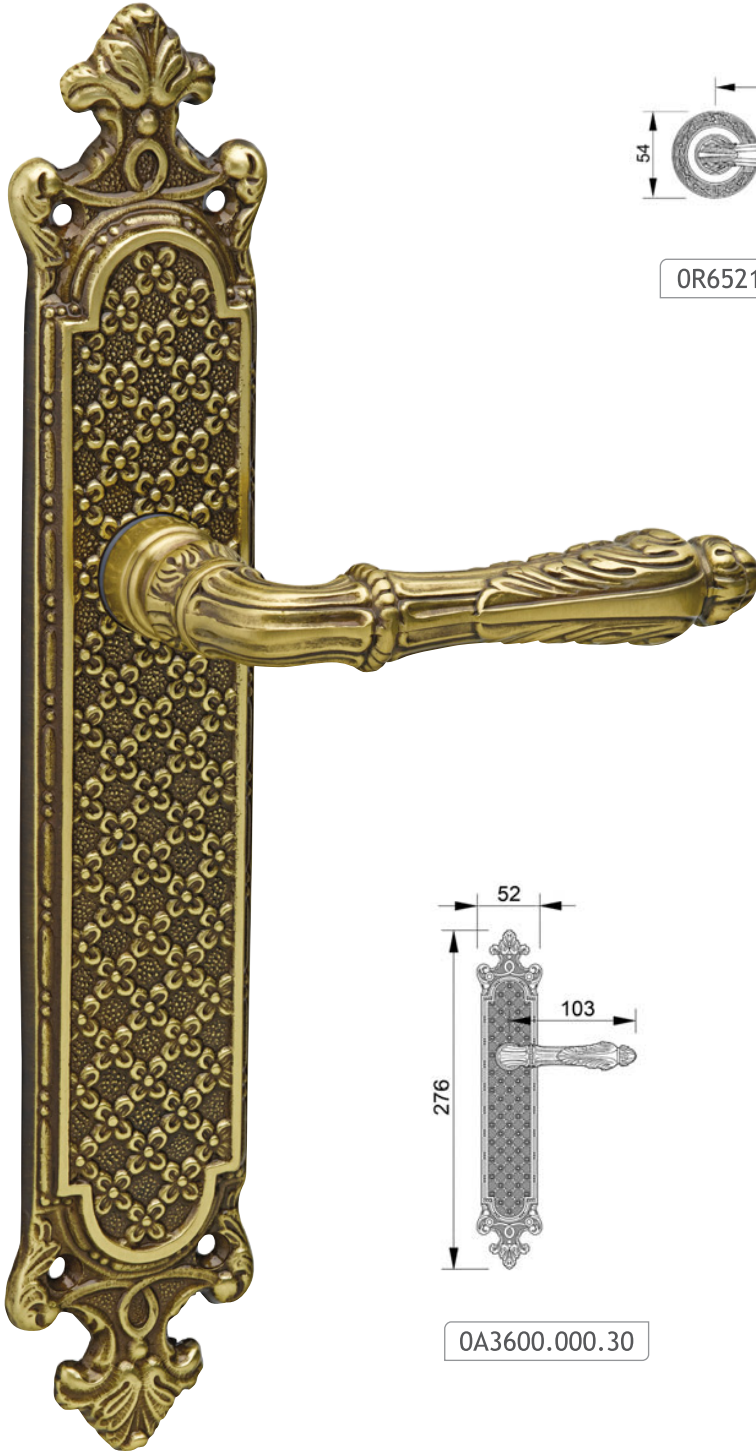

0A3600.000.30

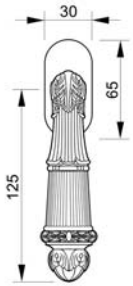

0V0720.000.30

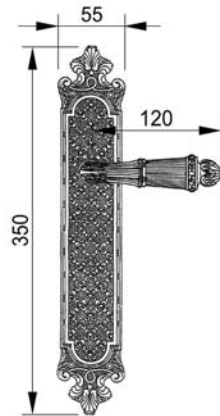
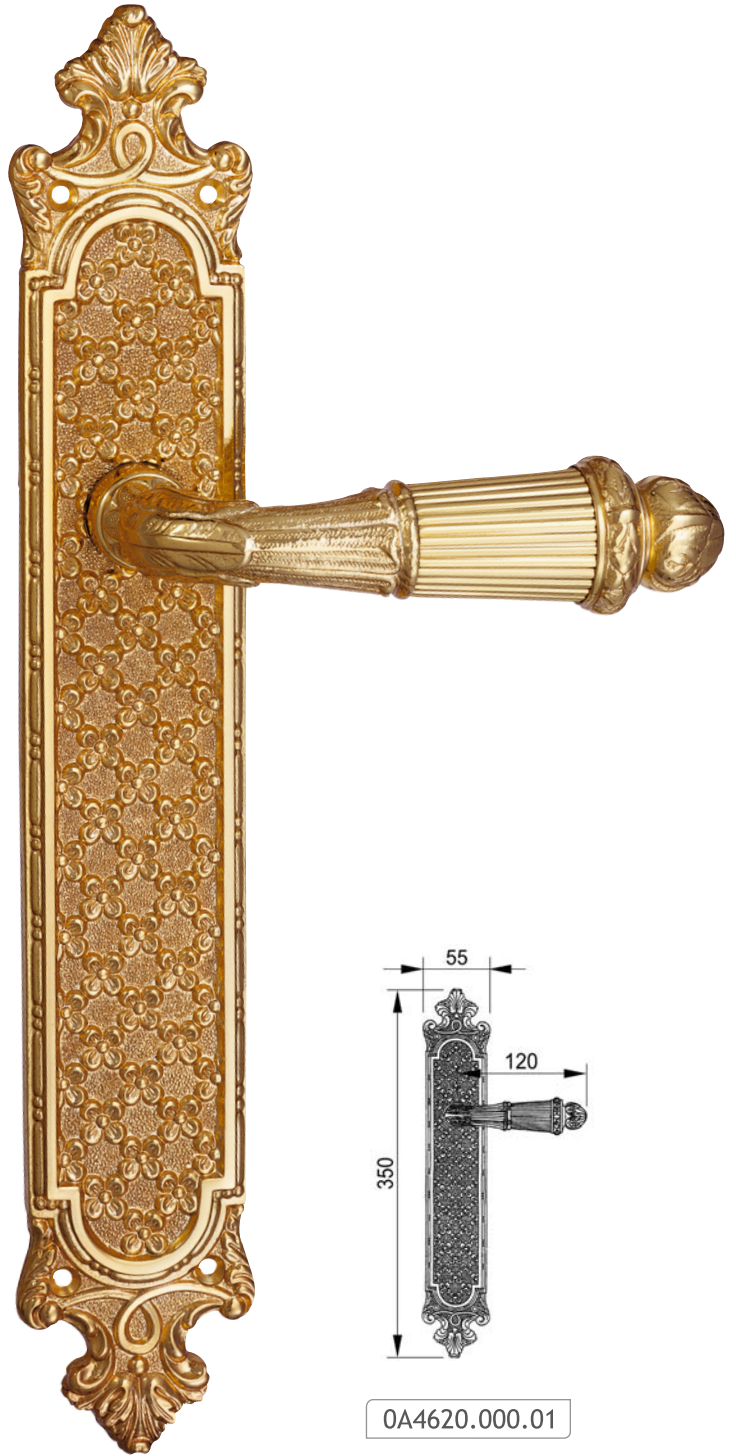

0A4620.000.01

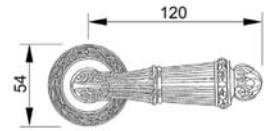

OR6520.000.30

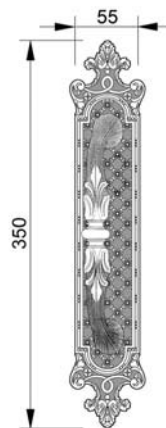

OM4632.000.01

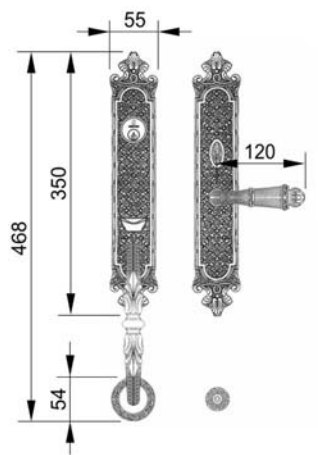
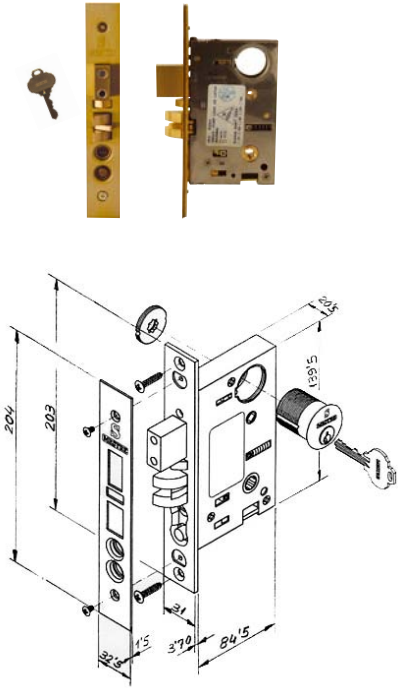

OJ4604.D00.43



0J4606.85Y.72



0J4607.D85.44

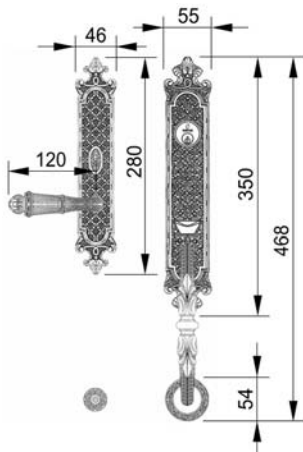
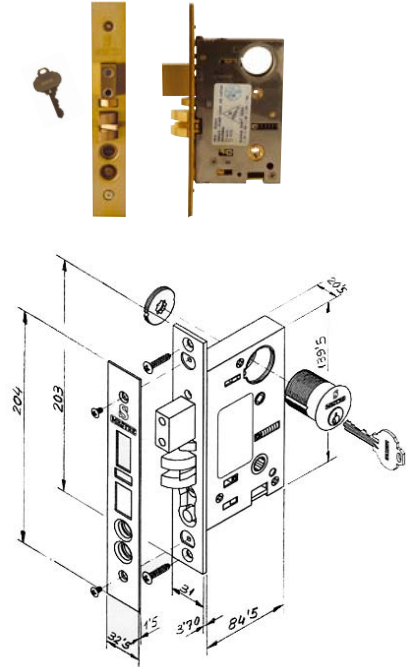

OJ3604.Z00.44

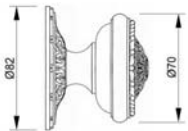

OC3616.000.01



OX4631.D85.01

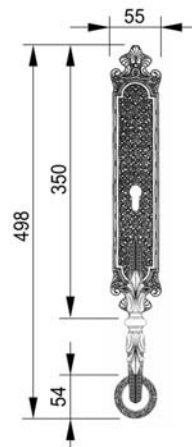

OX4631.D00.01

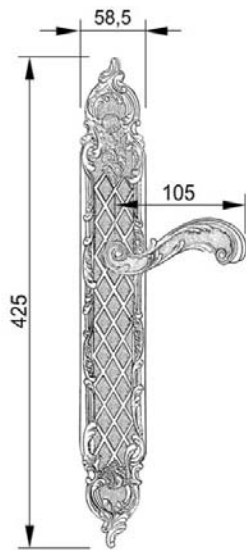

OA1616.000.44

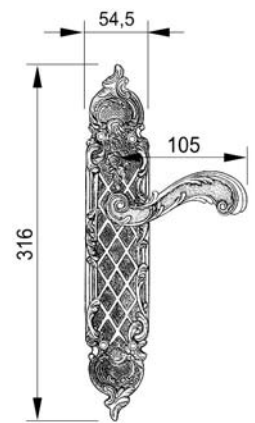

OA1716.000.01

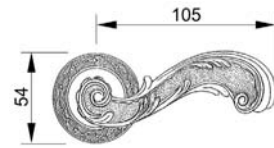

OR6516.000.44

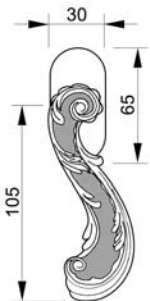

OV0716.D00.01

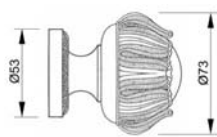

OC6538.000.43

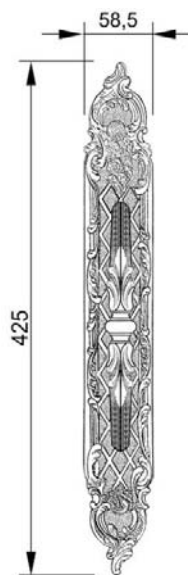

OM1602.000.30

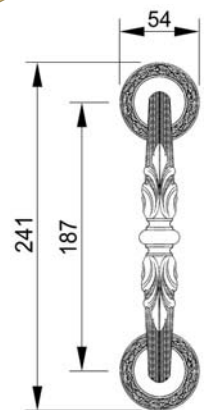

ON6505.000.44

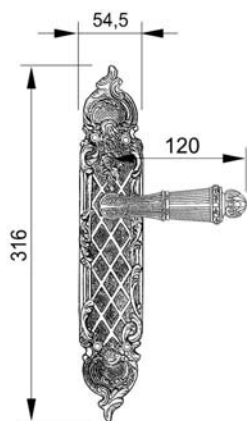

0A1720.85Y.30

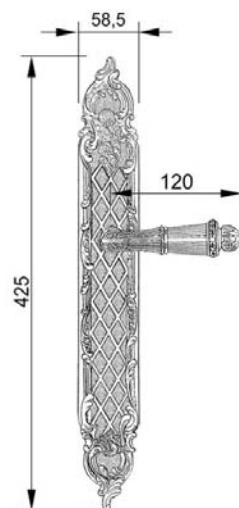

0A1620.85Y.01

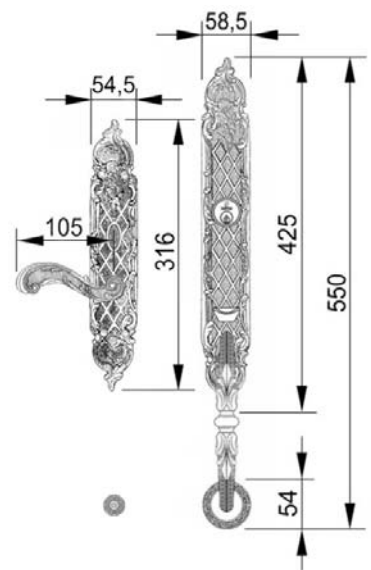
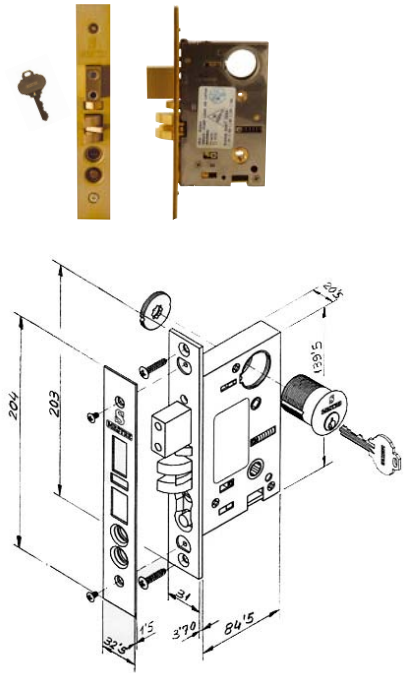

OJ1704.Z00.43



OJ1607.85Y.01

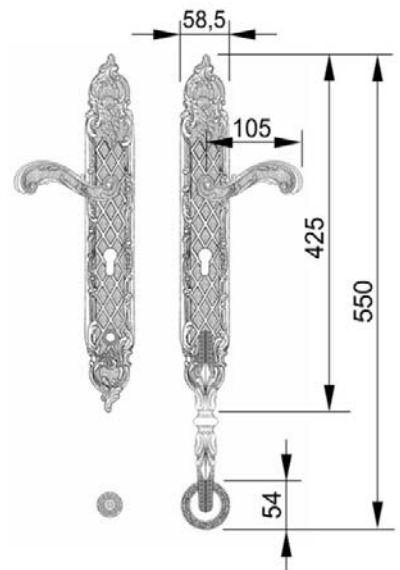

OJ1605.85Y.71

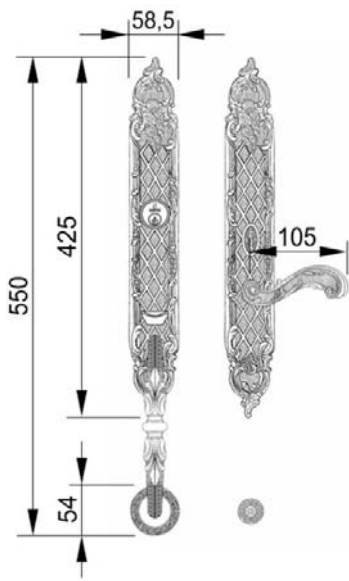
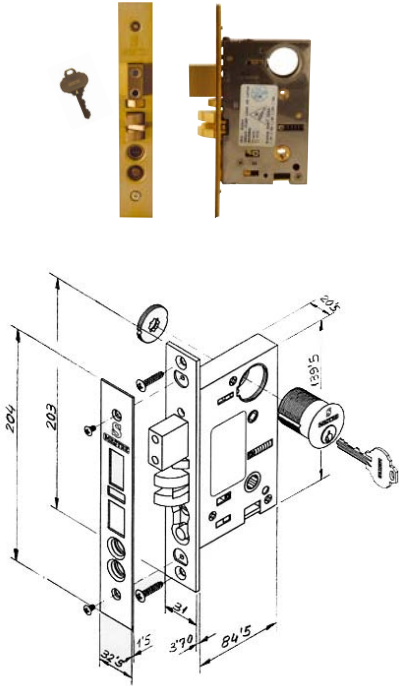

OJ1604.D00.62



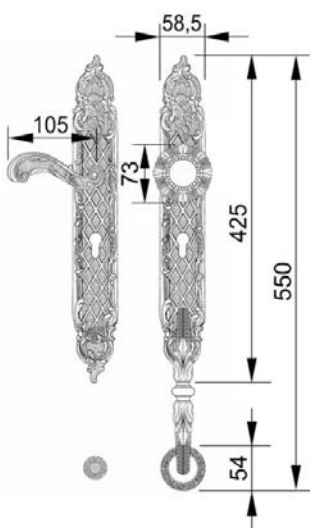

0J1609.Z85.01

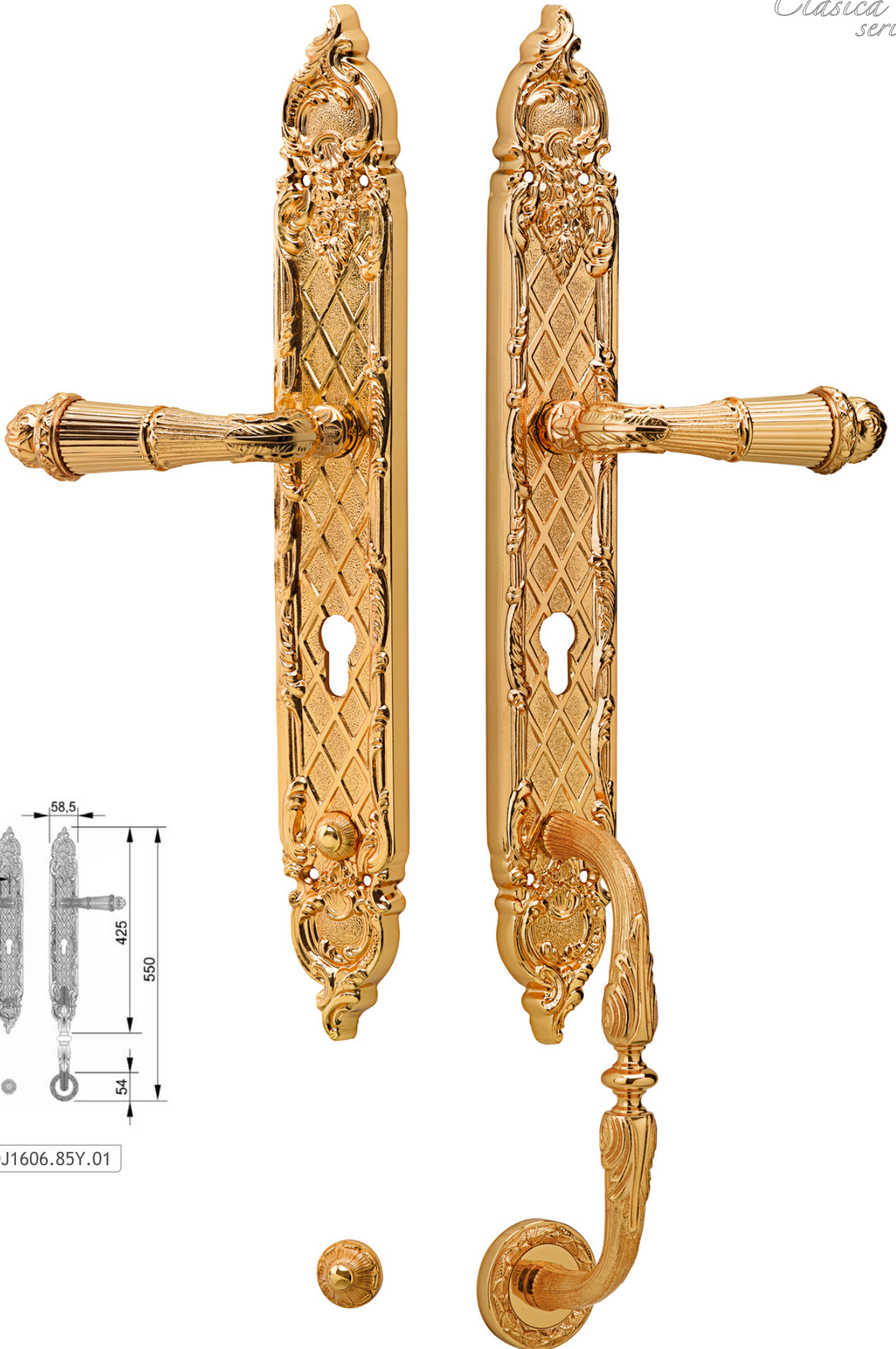

OJ1606.85Y.01

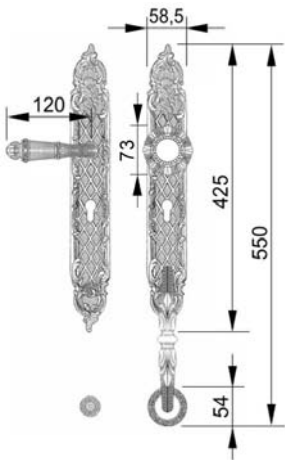

OJ1607.L85.44

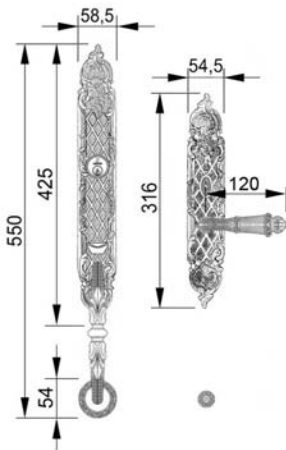

OJ1708.D00.30

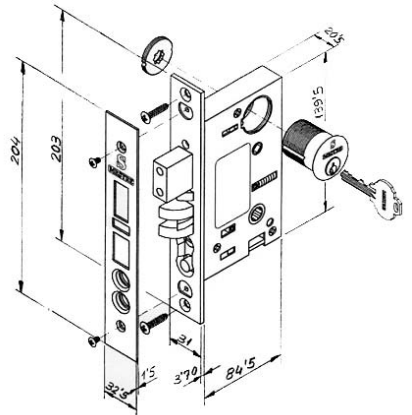
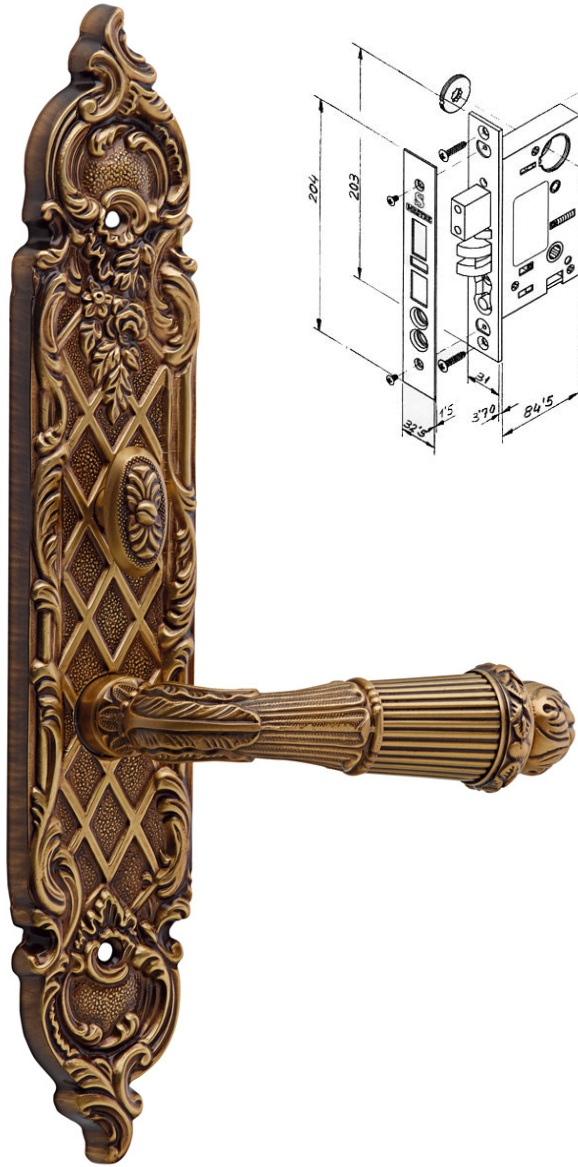

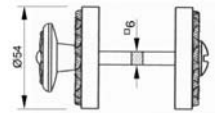

OWC065.6MM.01

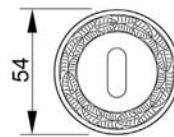

OBC065.000.01

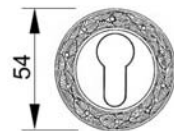

OEY065.000.71

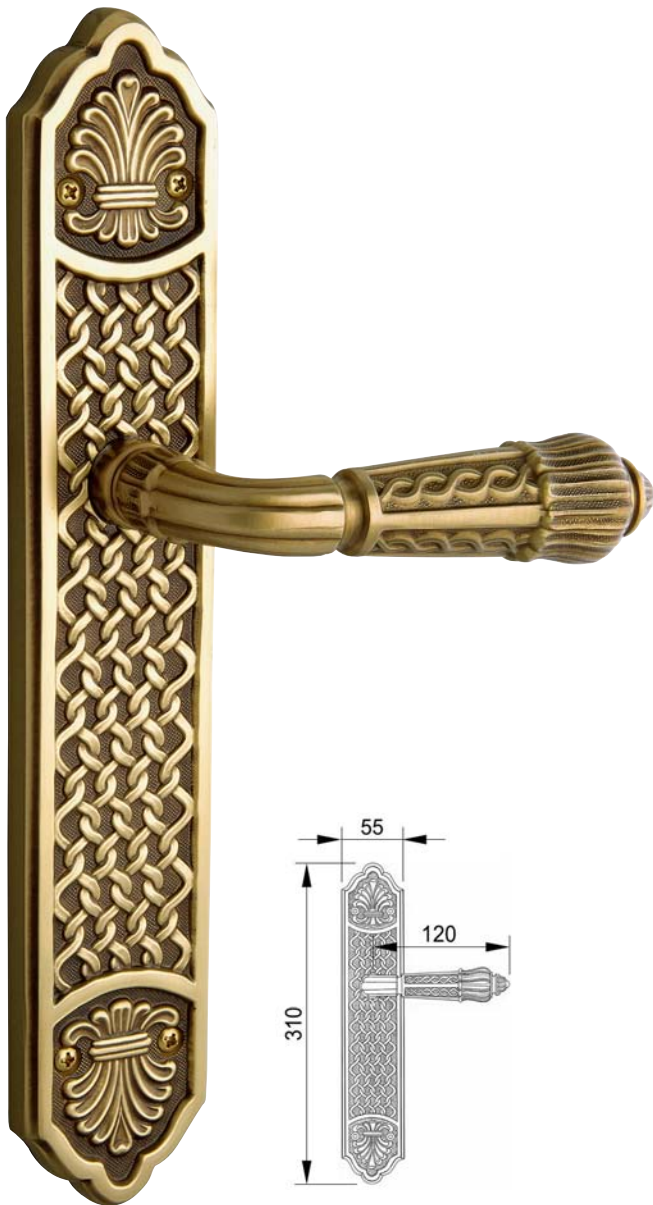

0A3130.000.44

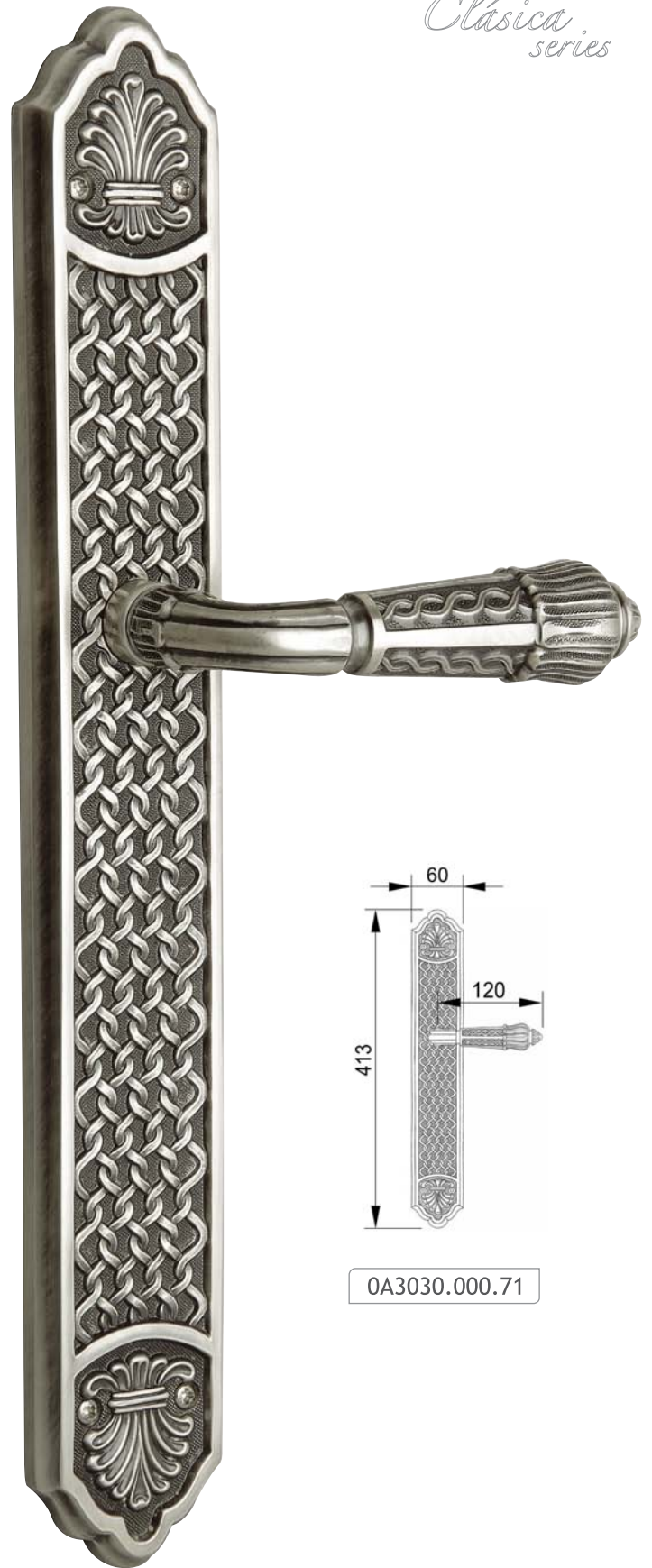

0A3030.000.71

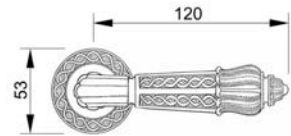

OR7030.000.44

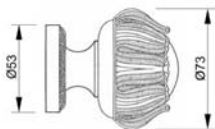

OC3016.000.44

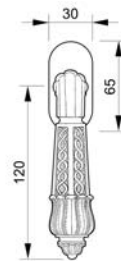

OV0730.000.44

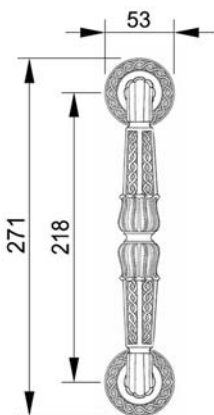

ON7002.000.01

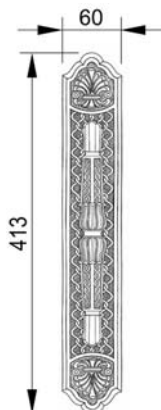

OM3002.000.01

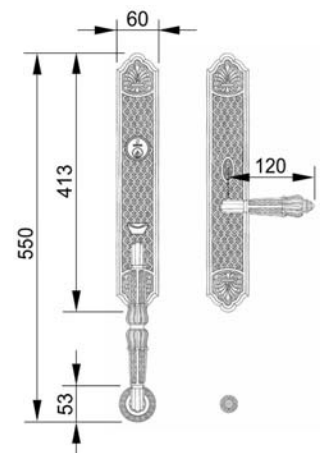
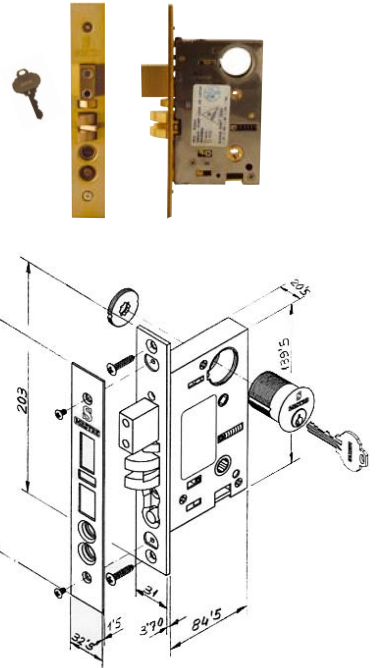

OJ3004.D00.71



0J3007.Z85.01

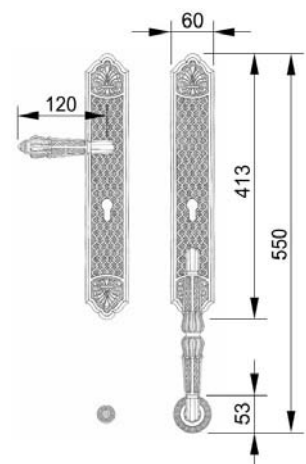

OJ3007.85Y.01

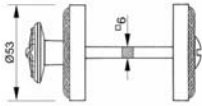

OWC070.6MM.71

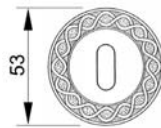

OBC070.000.71

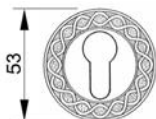

OEY070.000.71



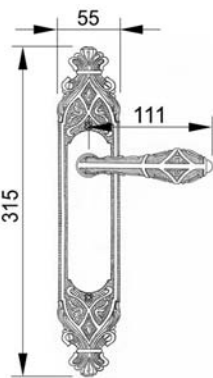
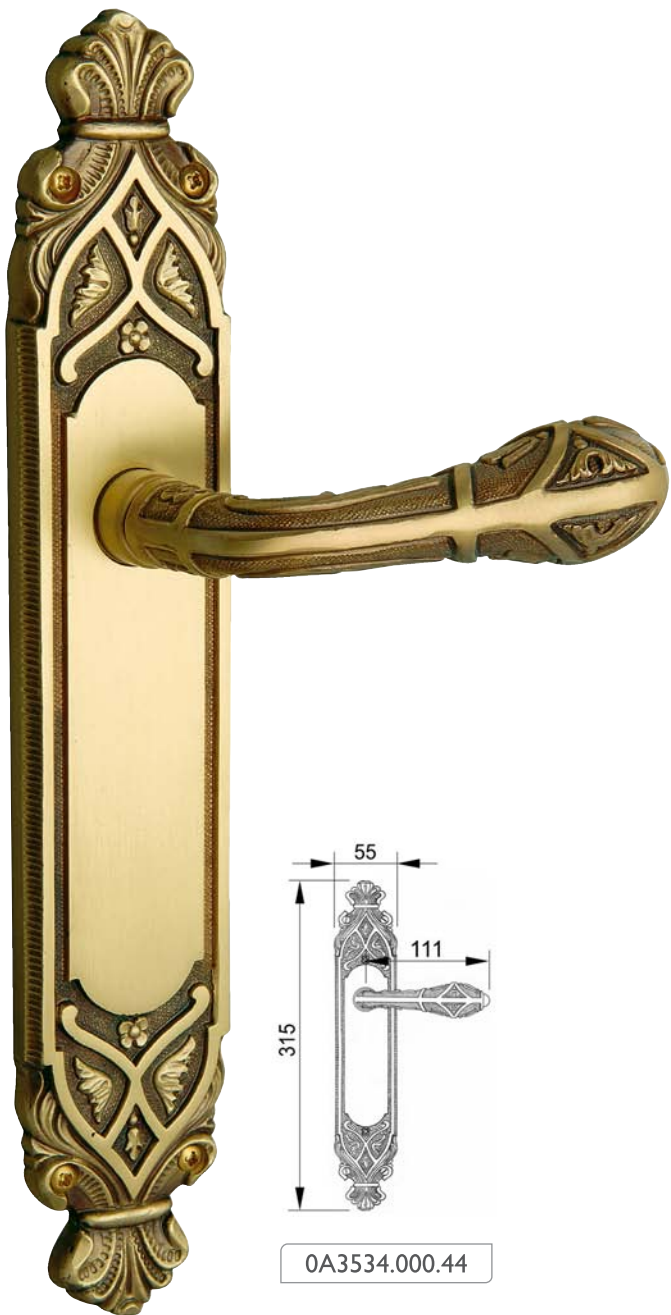

0A3534.000.44

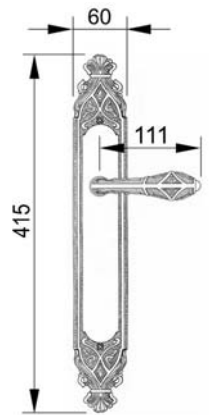
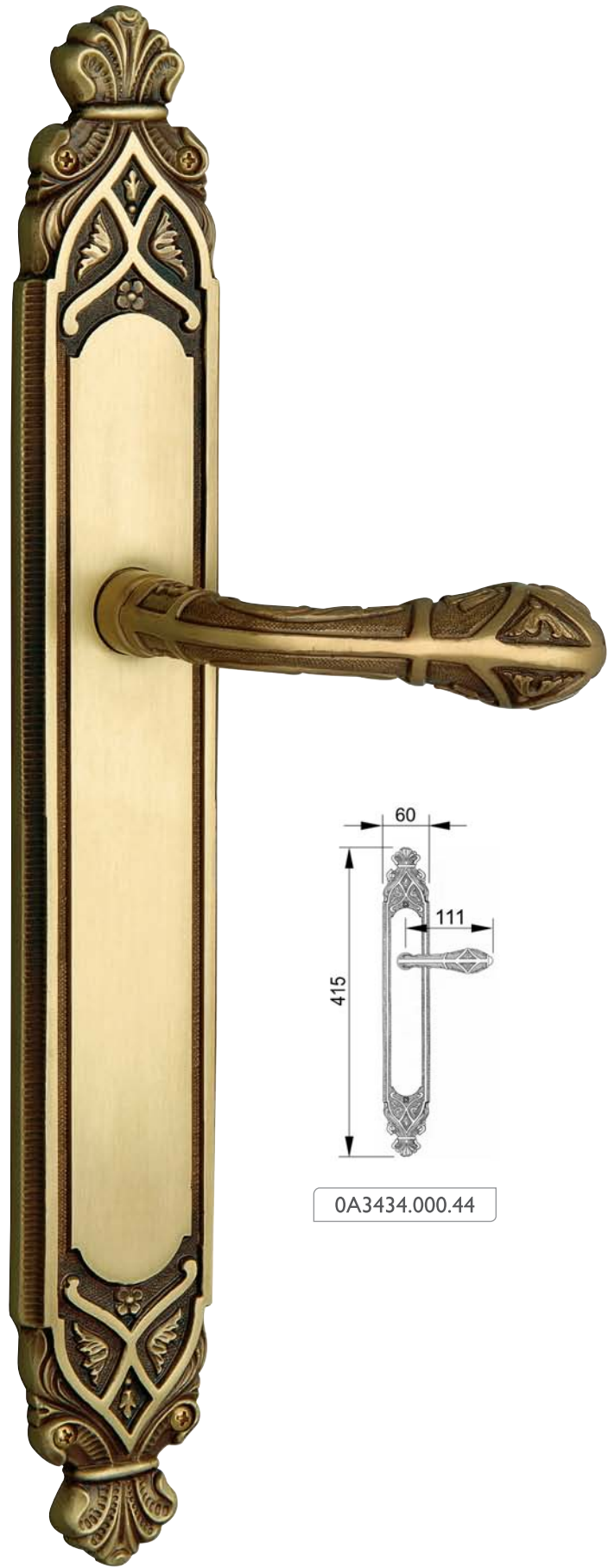

0A3434.000.44

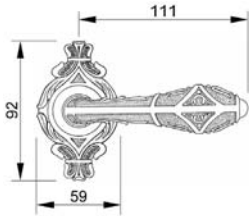

OR7134.000.44



OR7134.EY0.44

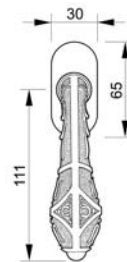
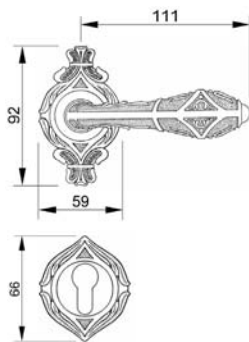

OV0734.000.44

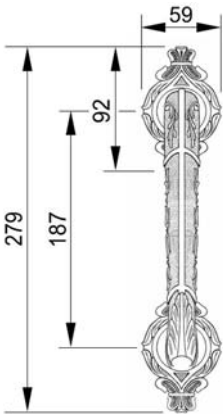

ON7102.000.44

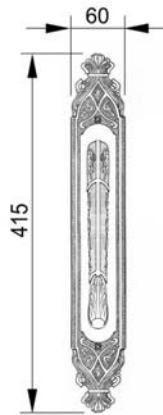

OM3402.000.44

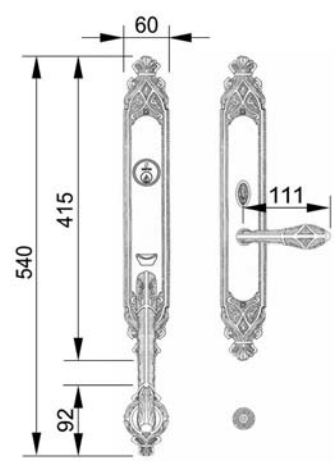
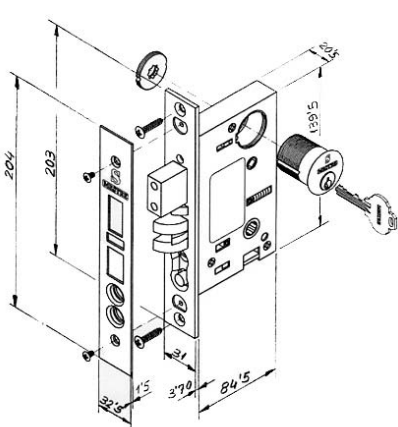

0J3404.D00.44



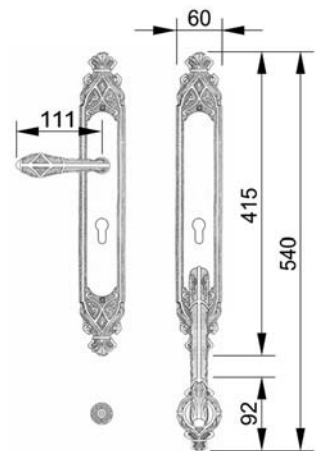

OJ3407.85Y.44

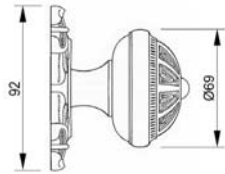

0C3416.000.44

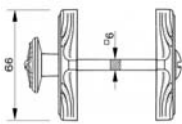

0WC073.6MM.44

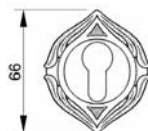

0EY073.000.44



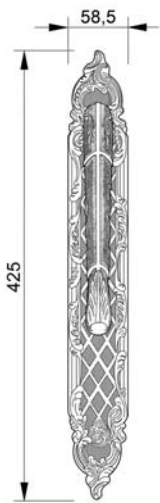

OM1603.B00.01



OM3003.B00.01

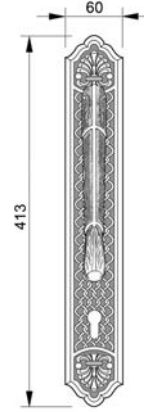

OM3003.BY0.01



OM1603.BY0.62

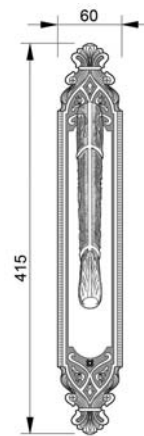

OM3403.B00.44





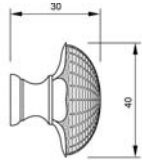

OZ0694.000.43

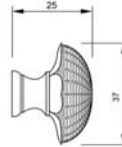

OZ0695.000.43

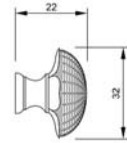

OZ0696.000.43

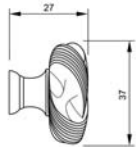

OZ0711.000.30

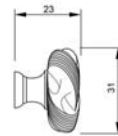

OZ0712.000.30

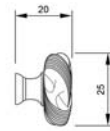

OZ0713.000.30

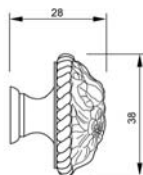

OZ0987.000.71

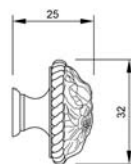

OZ0988.000.71

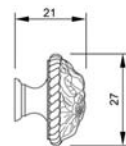

OZ0989.000.71

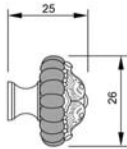

0Z1242.000.12

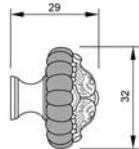

0Z1241.000.12

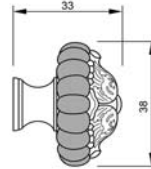

0Z1240.000.12

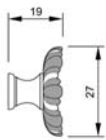

0Z1183.000.01

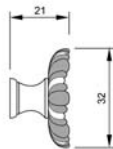

0Z1182.000.01

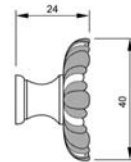

0Z1181.000.01

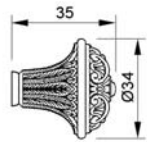

0Z5757.000.01

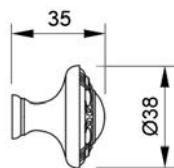

0Z5758.000.30



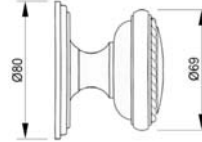

OC2916.000.34

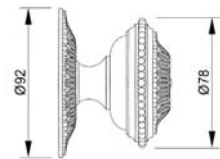

OC0862.863.01

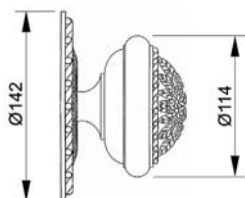

OC0594.595.01

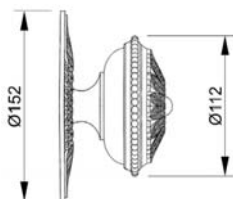

OC0860.861.43



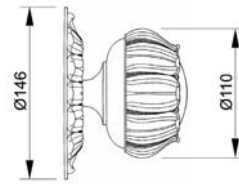

OC0649.650.71

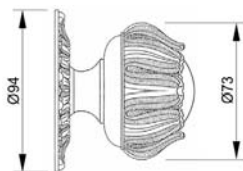

OC0651.652.01





Detalle juego de manillones, fijación oculta.
Set of pull handles, concealed back to back fixing.

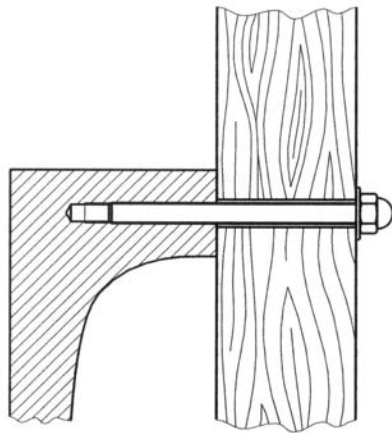

Fijación manillón simple
Single Pull handle fixing assembly

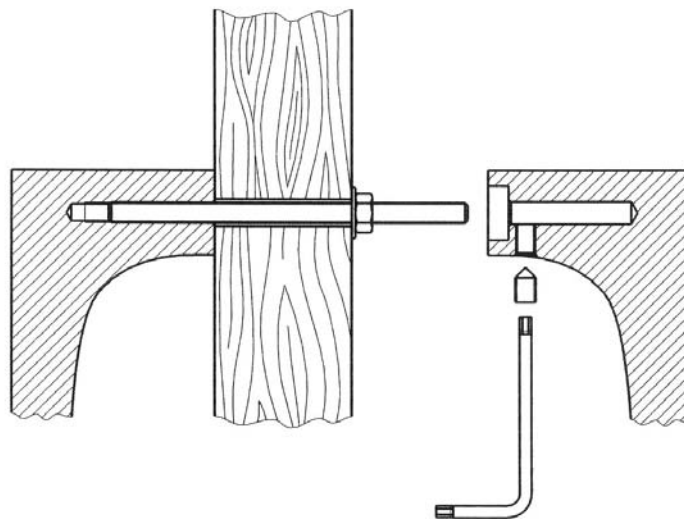

Montaje juego manillones
Concealed back to back fixing assembly set of pull handles.

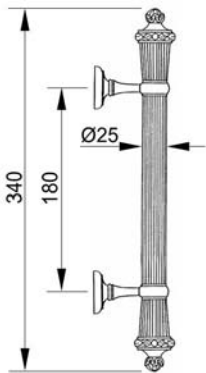

0N4776.000.01

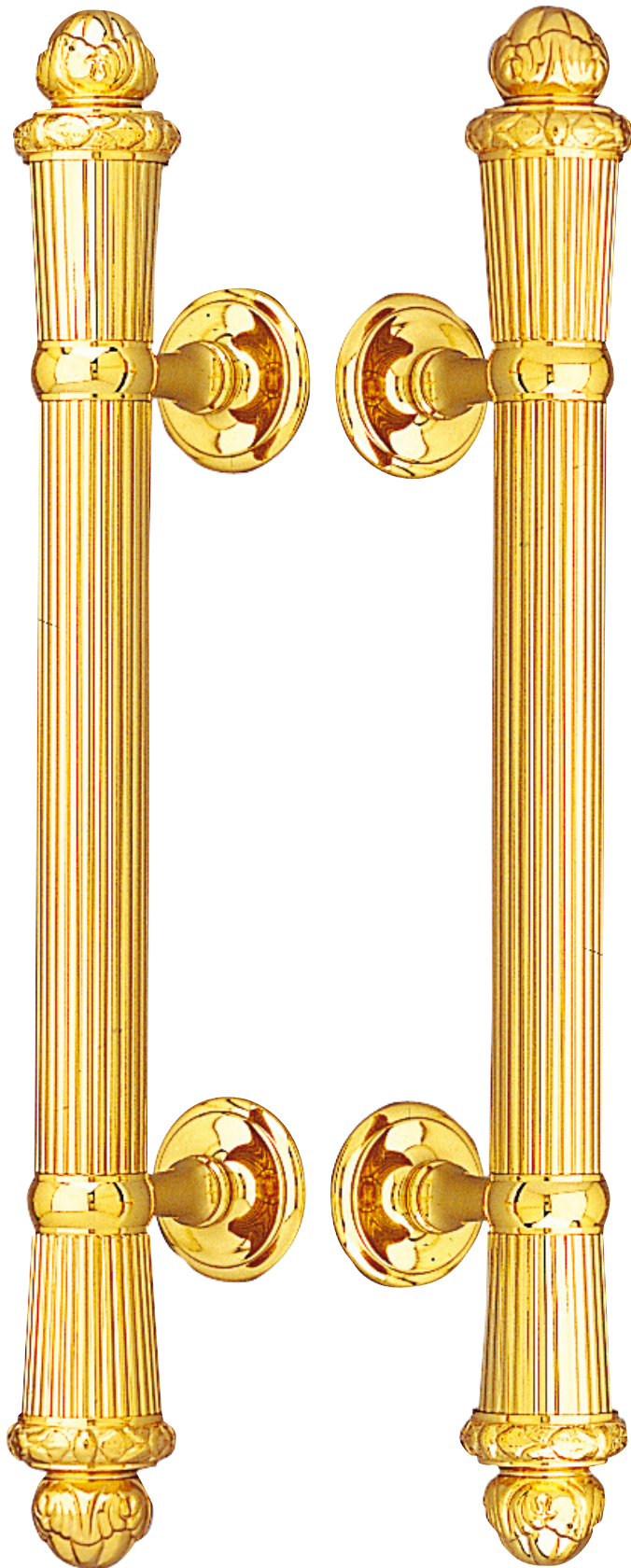

JUEGO / SET

0N4777.000.01

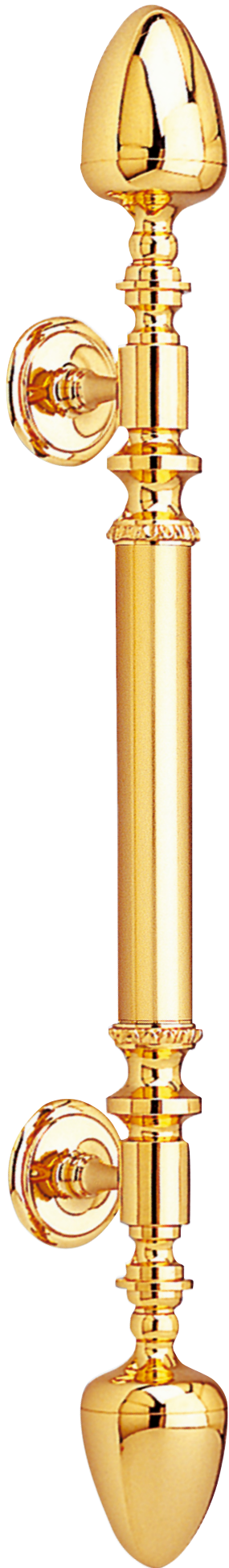

JUEGO / SET

ON4483.000.01

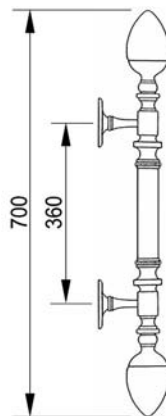

ON4482.000.01

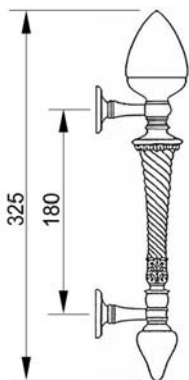

0N4676.000.62

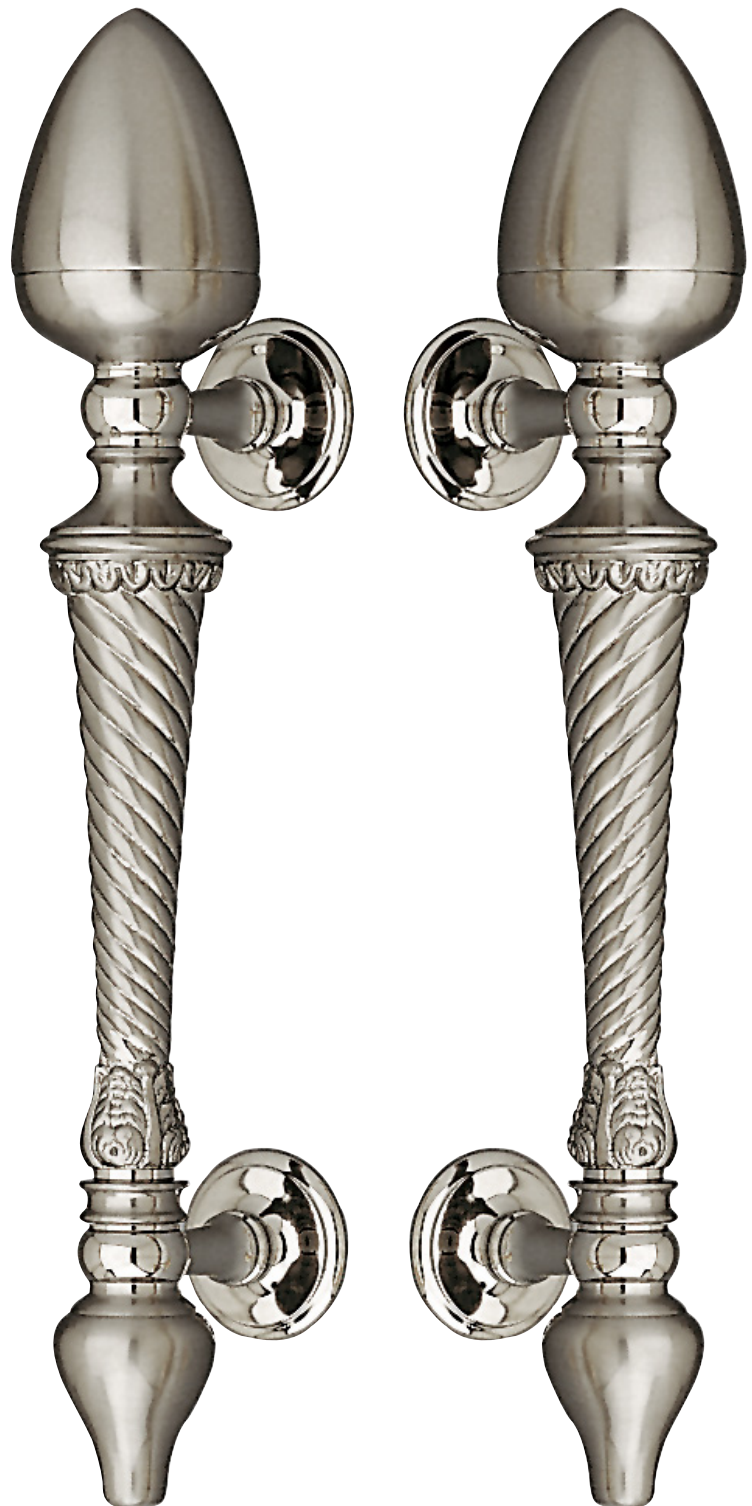

JUEGO / SET

0N4677.000.62

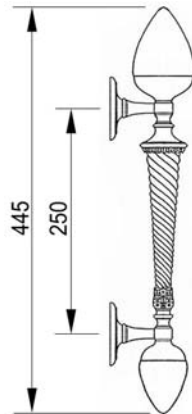

0N4486.000.01



JUEGO / SET
0N4487.000.01



JUEGO / SET
0N4485.000.44

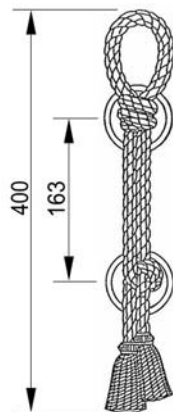

0N4484.000.44

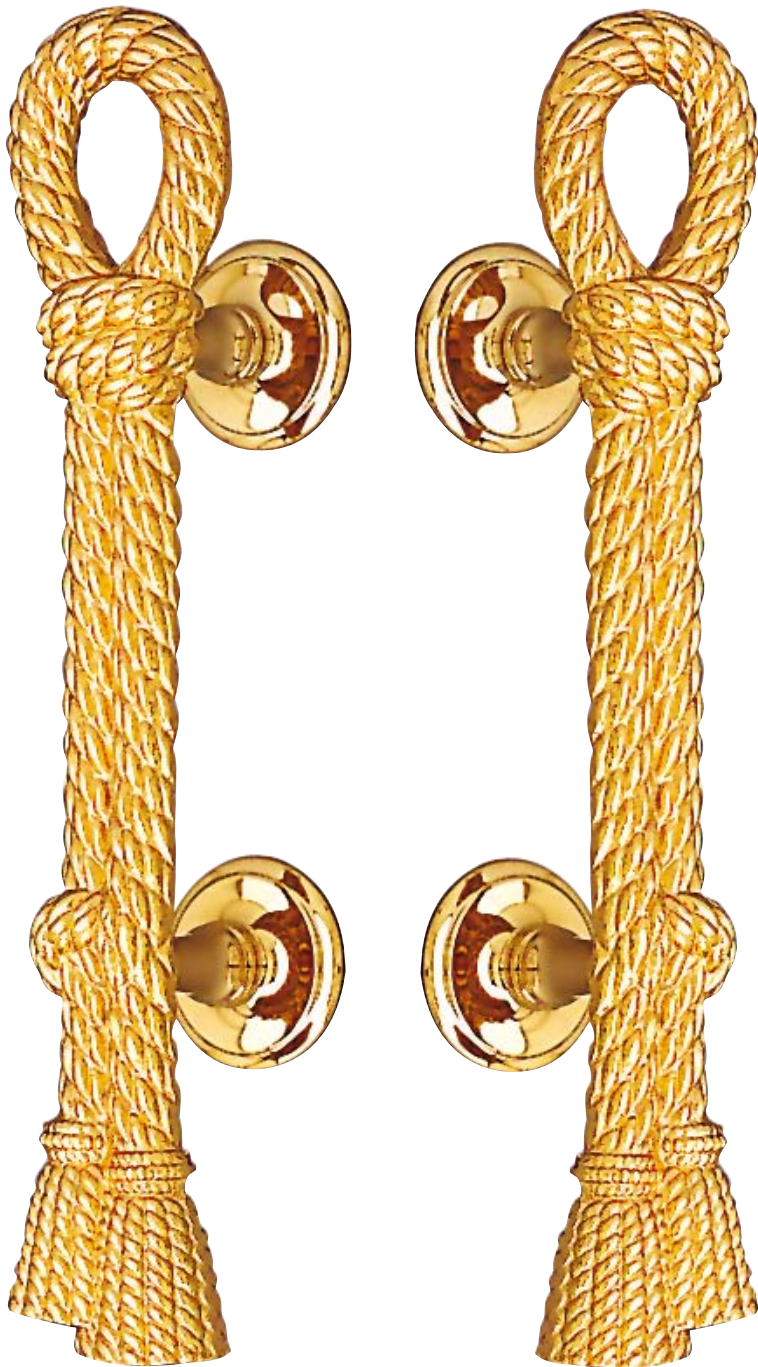

JUEGO / SET

0N4675.000.01

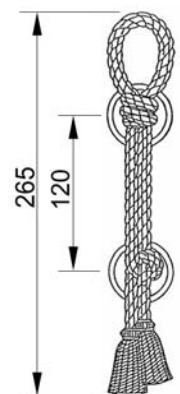

0N4674.000.01

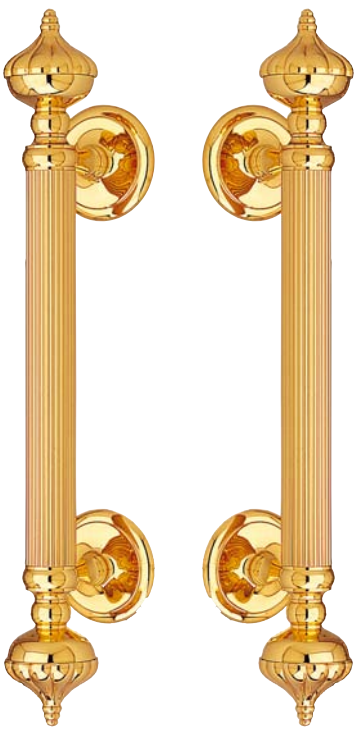

JUEGO / SET

0N4769.000.01

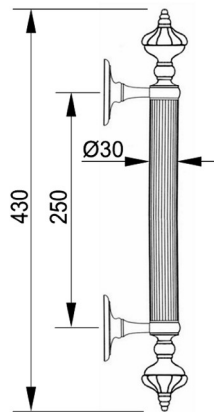

0N4768.000.01

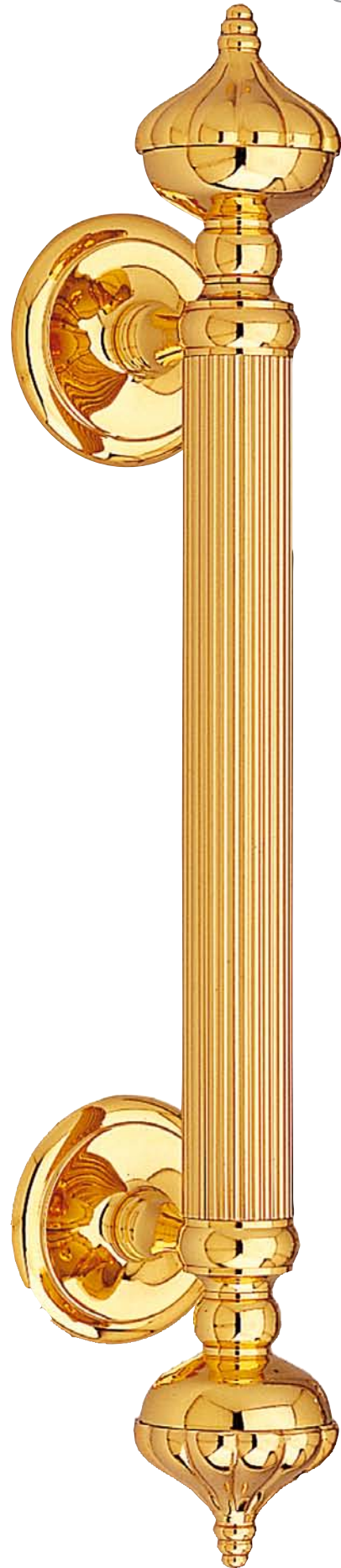

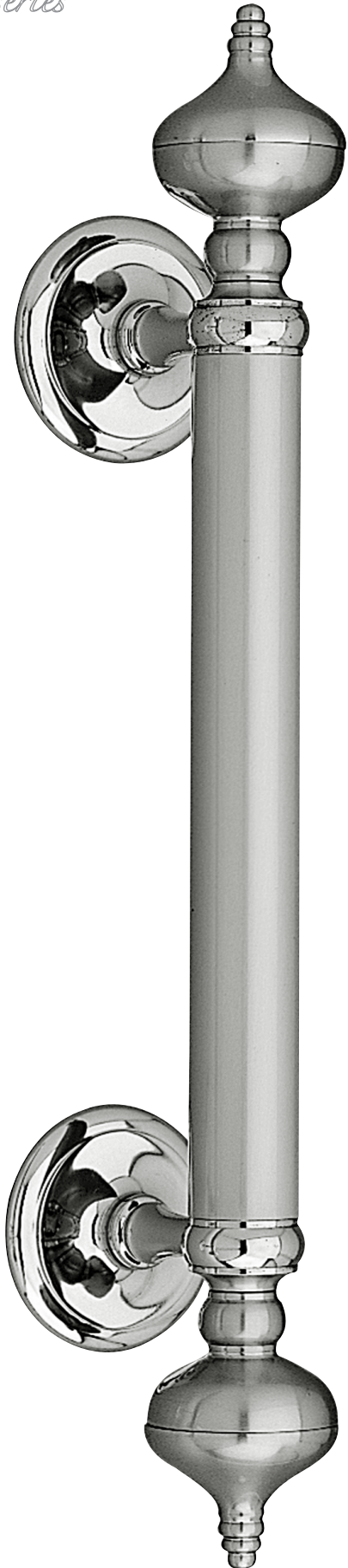

JUEGO / SET

0N4775.000.62

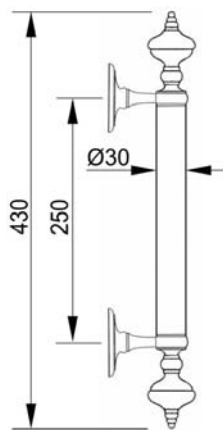

0N4774.000.62



JUEGO / SET

0N4699.000.62

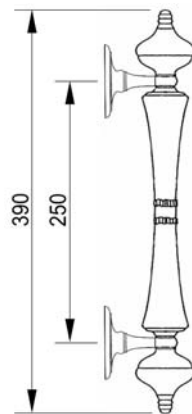

0N4698.000.62

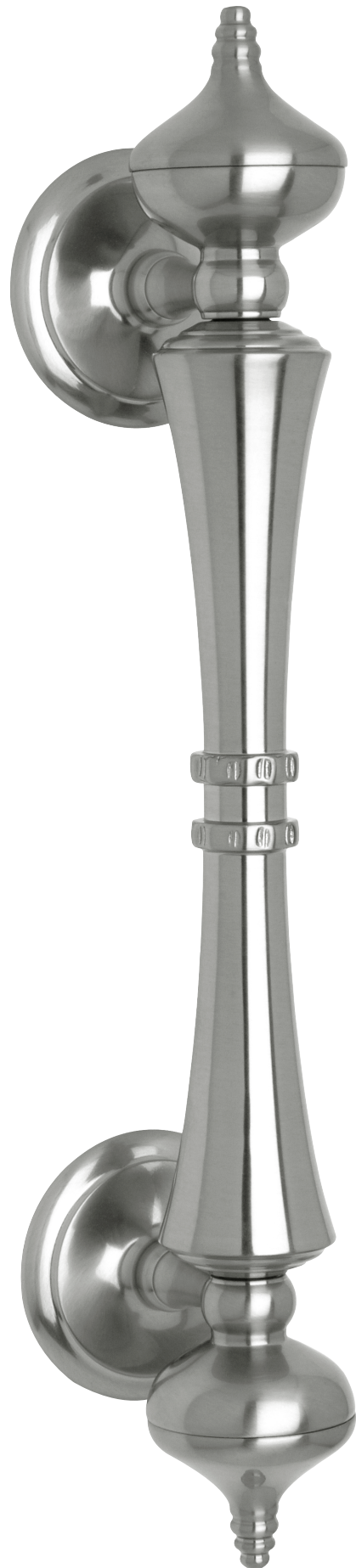



JUEGO / SET

ON4697.000.62

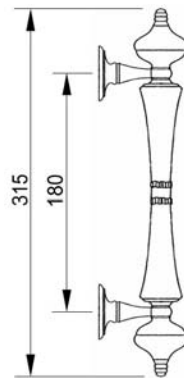

ON4696.000.62

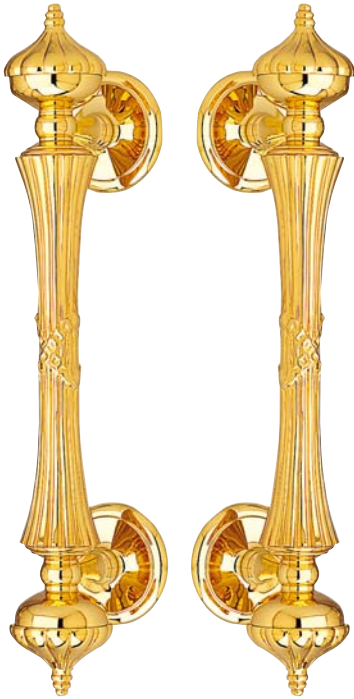

JUEGO / SET

0N4695.000.01

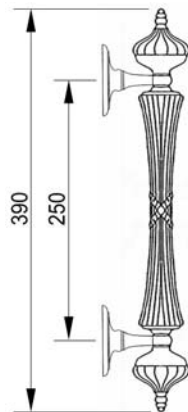

0N4694.000.01



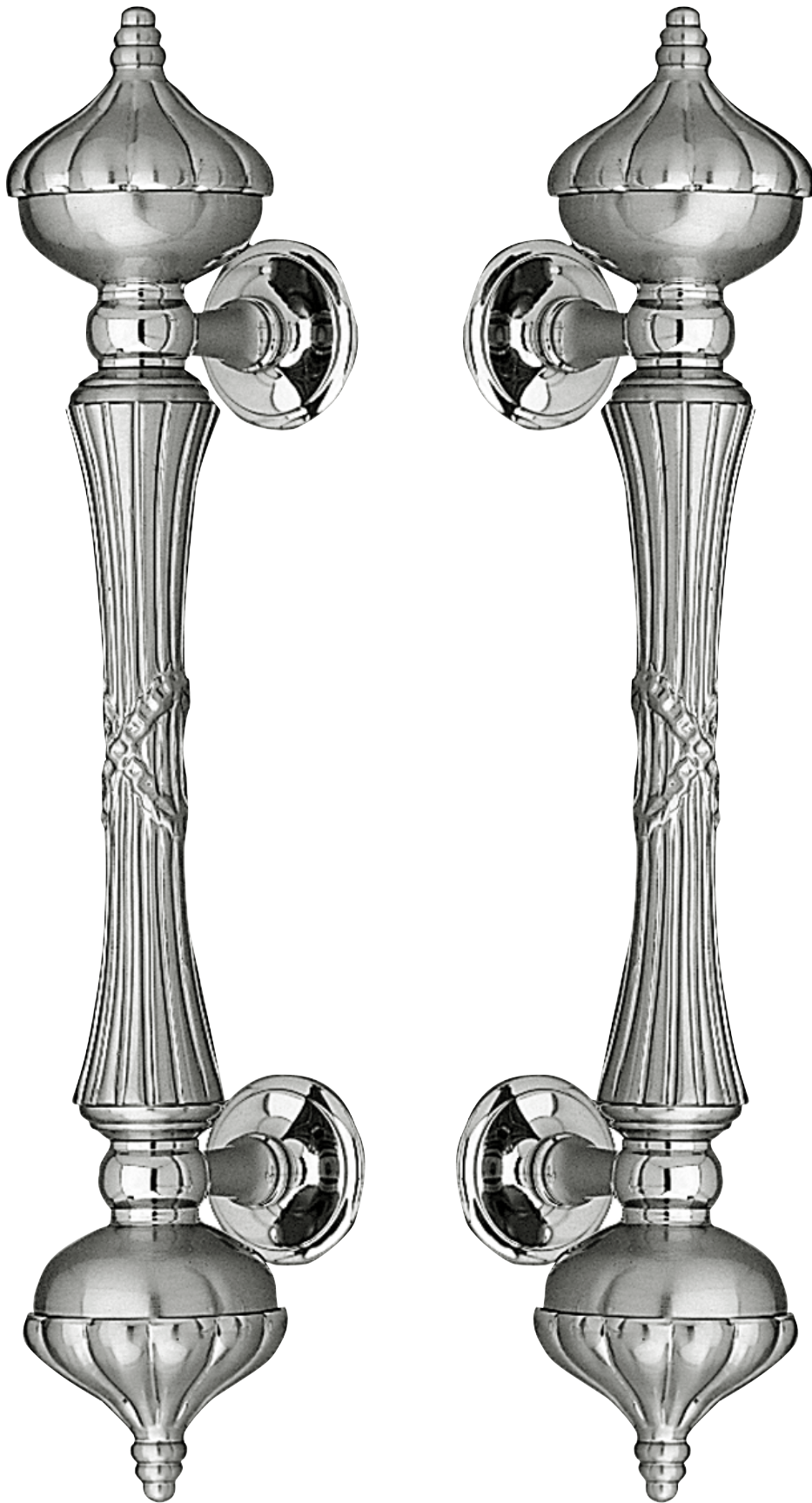

JUEGO / SET

0N4693.000.62

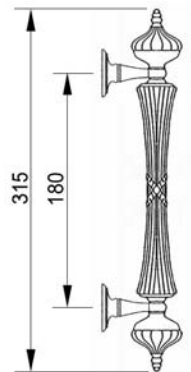
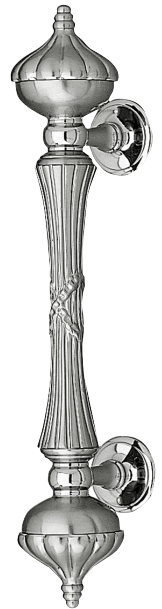

0N4692.000.62

