

MESTRE

LUXURY SINCE 1952

FURNITURE PULL HANDLES



www.broncesmestre.com

DECORATIVE FURNITURE PULL HANDLES

WITH HANDICRAFT DETAILS, GEMSTONES &
SWAROVSKI CRYSTALS

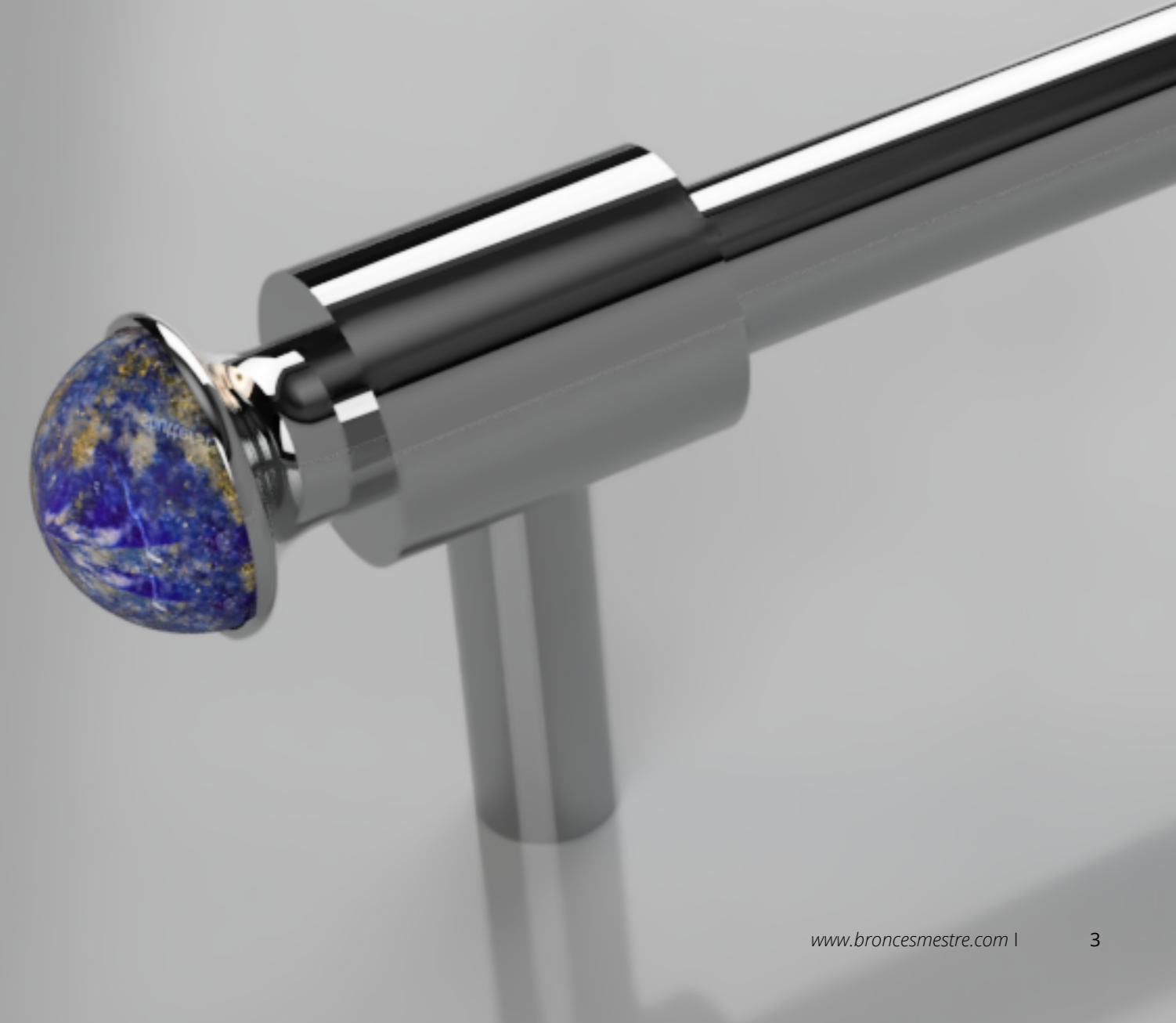



Discover our fantastic range of jewellery-inspired furniture pull handles created to embellish and enhance doors and drawers.



WITH DECORATIVE
HANDICRAFT DETAILS



WITH DECORATIVE
SWAROVSKI CRYSTALS



WITH DECORATIVE
GEMSTONES

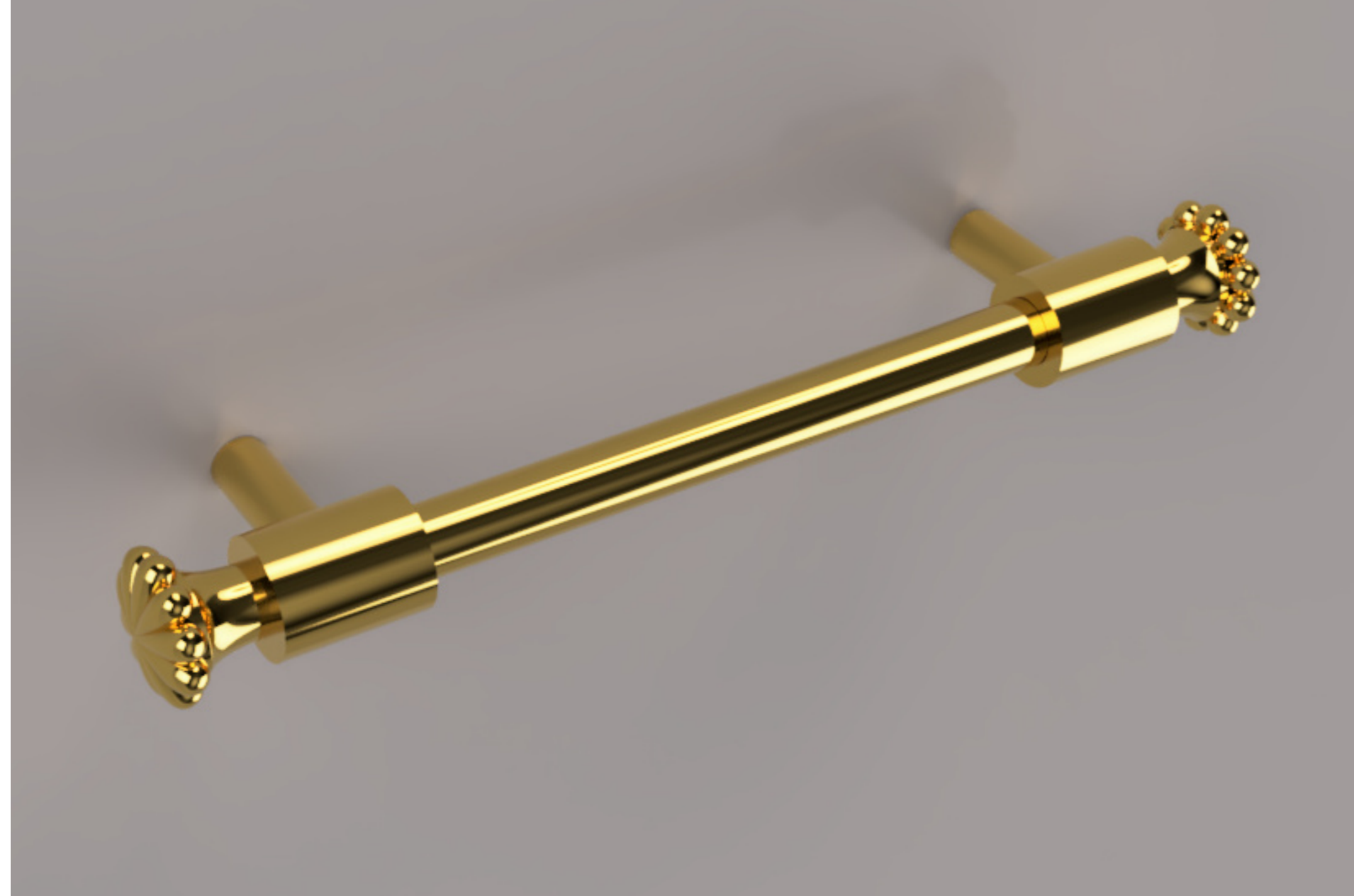

FURNITURE HANDLES WITH DECORATIVE HANDICRAFT DETAILS



ARTISANAL ESSENCE

The essence of our production philosophy lies in the constant search for perfection. Each piece in this collection must shine like an elegant jewel for the home, which is why our master craftsmen delicately work each piece in pursuit of the highest quality and perfection.

These elegant and contemporary furniture handle designs can be combined with our faucet collections, as they share the same style and handcrafted details.



MESTRE
LUXURY SINCE 1952

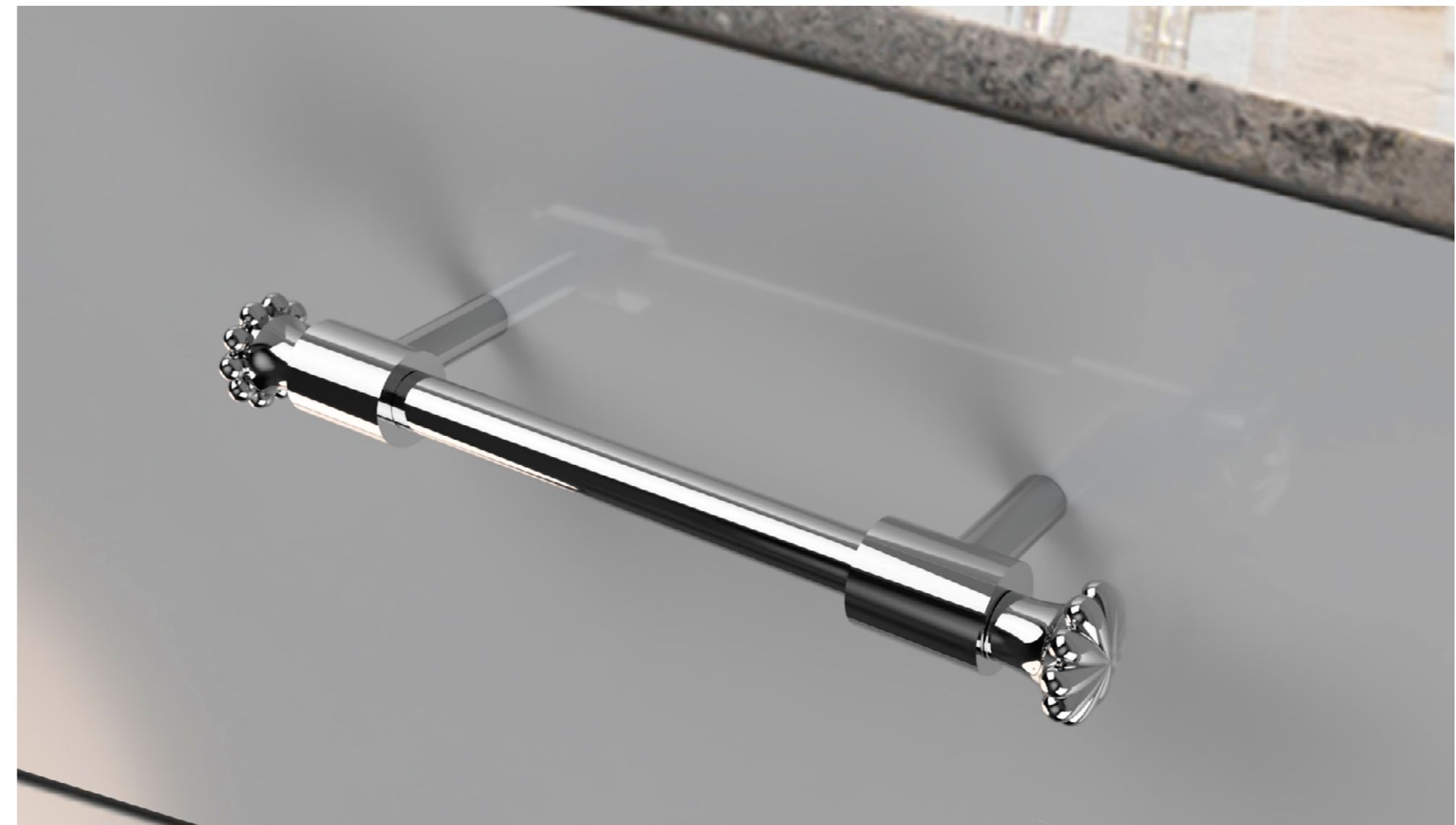

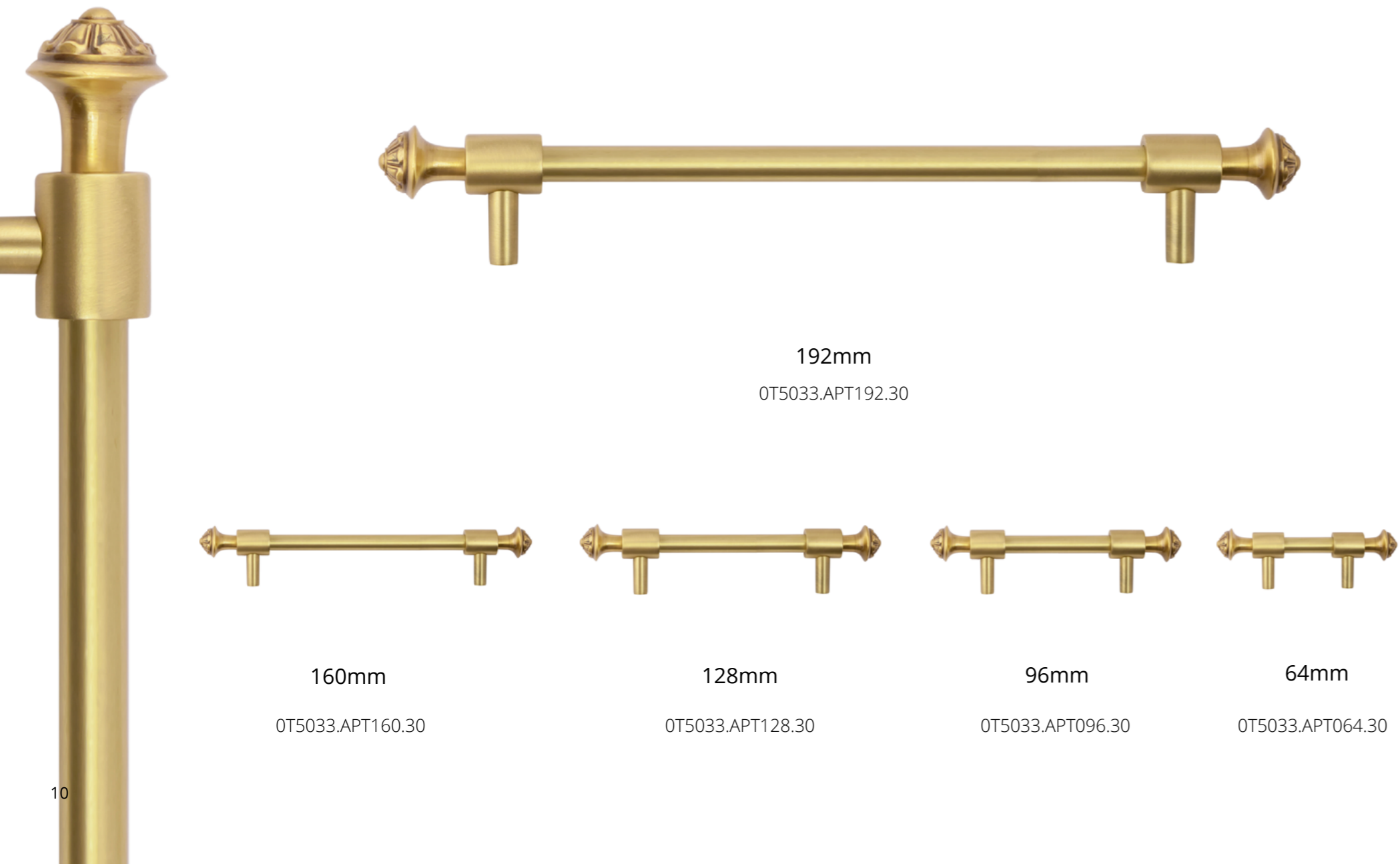

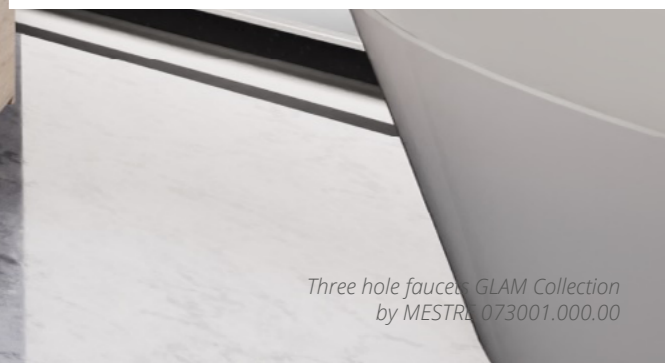

Three hole faucet GLAM Collection
by MESTRE 073001.000.00

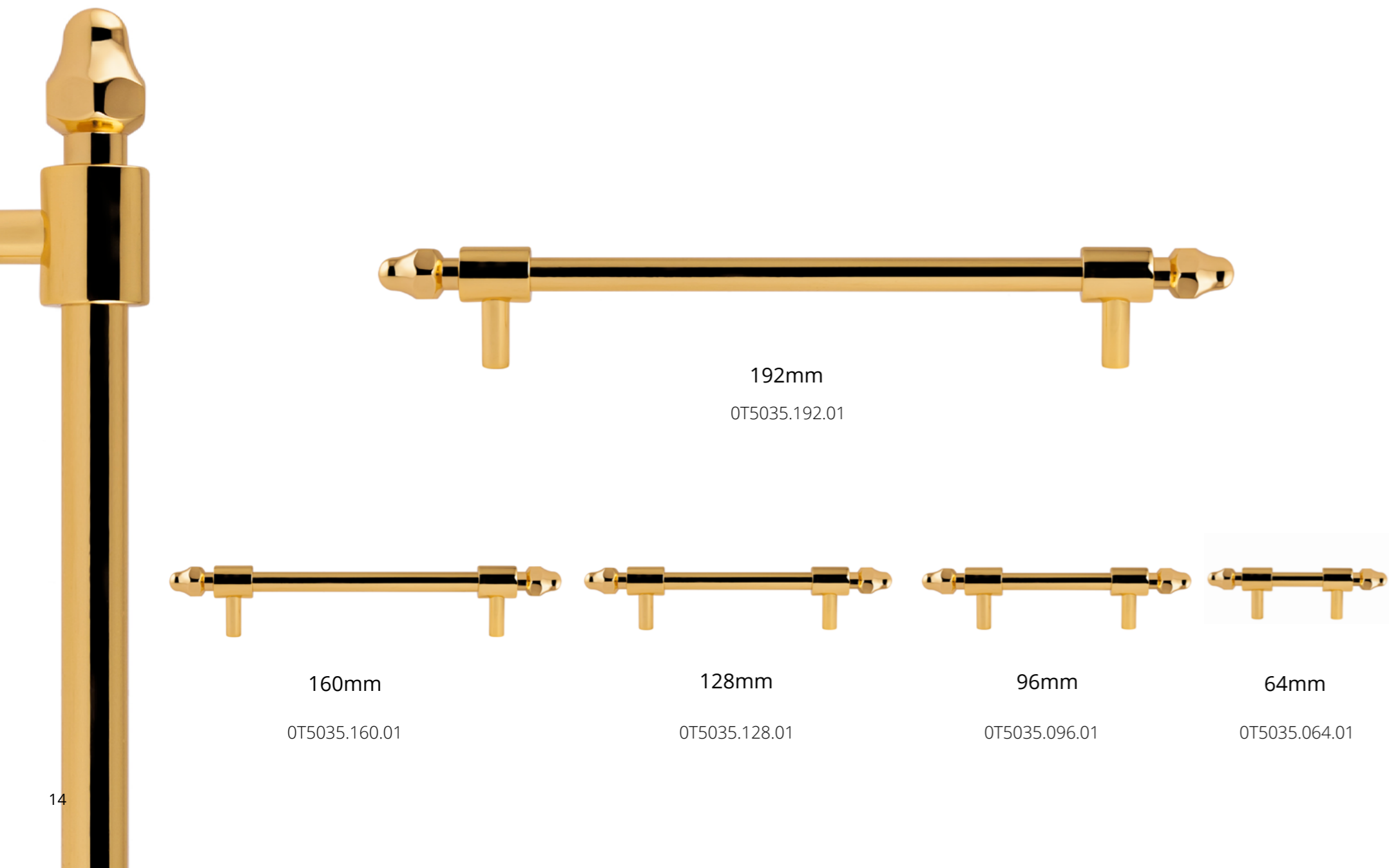

Two hole faucet with Swarovski crystal inlay from Soho Collection by MESTRE 071408.LP0.50

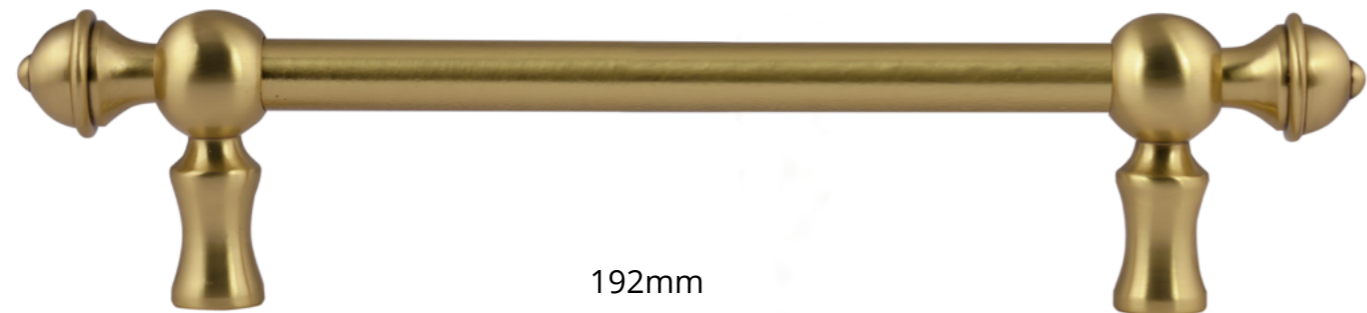

192mm

0T6442.192.30



160mm

0T6442.160.30



128mm

0T6442.128.30



96mm

0T6442.096.30



64mm

0T6442.064.30



*Kitchen tap from The One Kitchen Collection by MESTRE 071031.X00.50
with customizable knob 046047.000.50*



FURNITURE HANDLES WITH DECORATIVE SWAROVSKI CRYSTALS



BRIGHT SOUL

With a brilliance that is unique in the world, Swarovski crystal has inspired our faucet and hardware designs to create authentic and dazzling creations.

These exclusive handles, available in clear or black Swarovski crystal, have been created to add sparkle, charm and glamour to your everyday life.

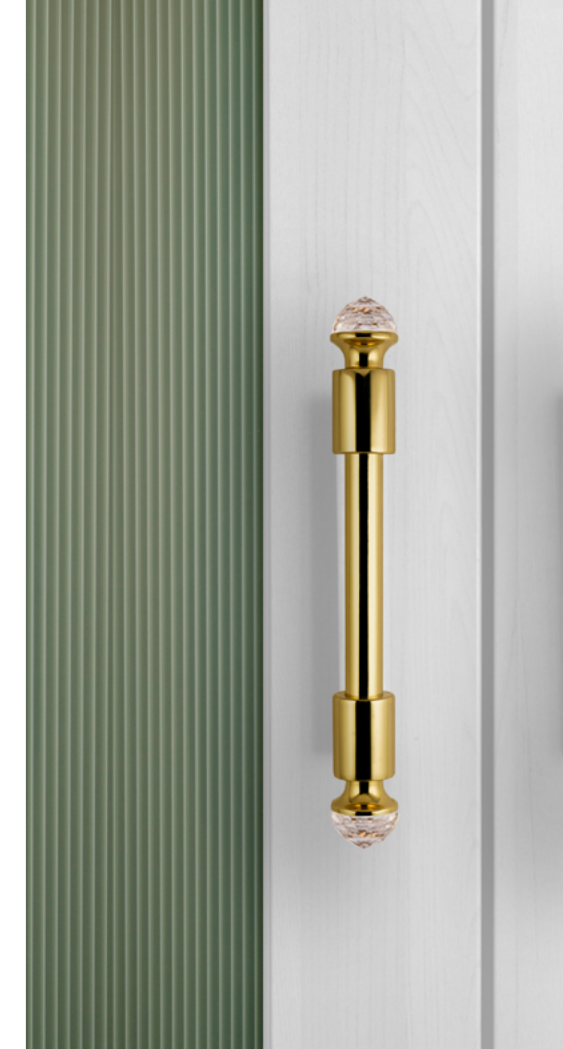
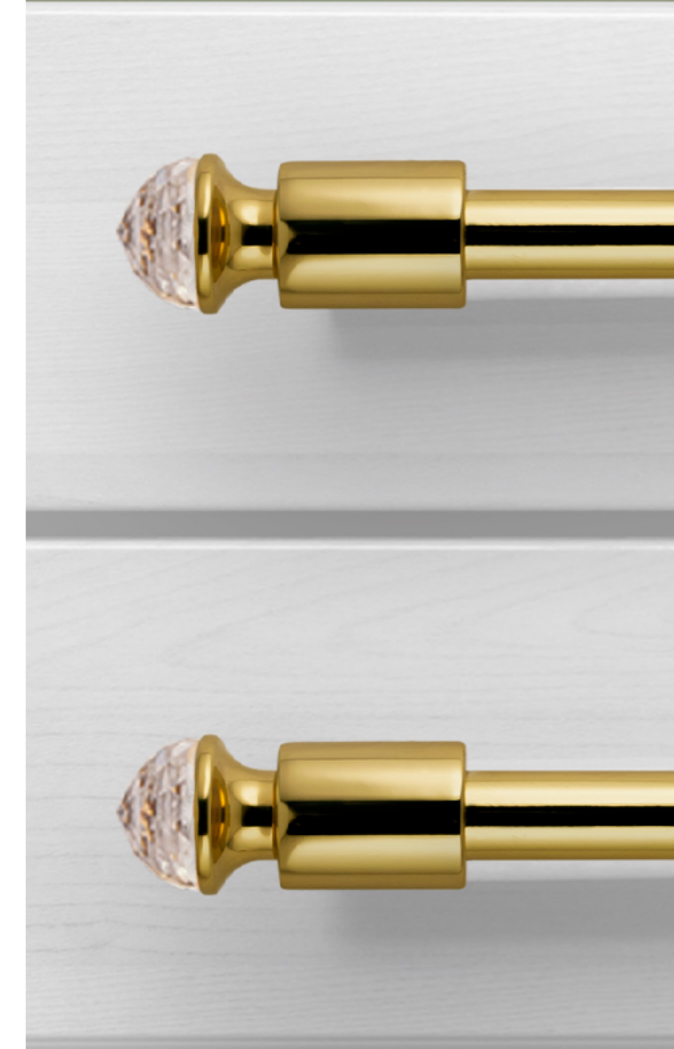

Furniture handles with decorative Swarovski crystal details



192mm



160mm



128mm

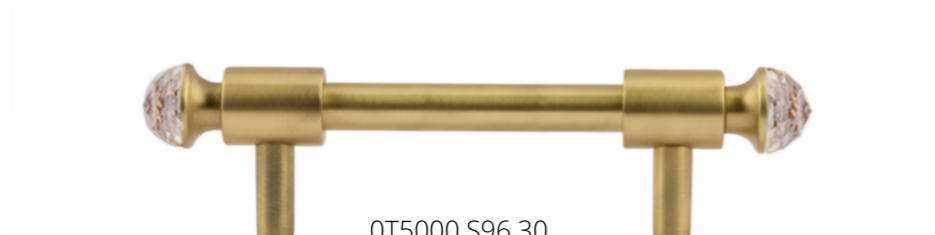

96mm



64mm



192mm



160mm



128mm



96mm



64mm





FURNITURE HANDLES WITH DECORATIVE GEMSTONES

NATURAL MAGNETISM

Feel the magnetism of nature through this jewellery-like collection with gemstones.

Natural stones such as quartz from igneous rocks that crystallise deep in volcanic magma, tiger's eye with its captivating veins full of contrasts, malachite with its characteristic hypnotic green hue, or the precious bluish lapis lazuli that transports you to the depths of the earth, give this simple and elegant handle design a unique touch of distinction.

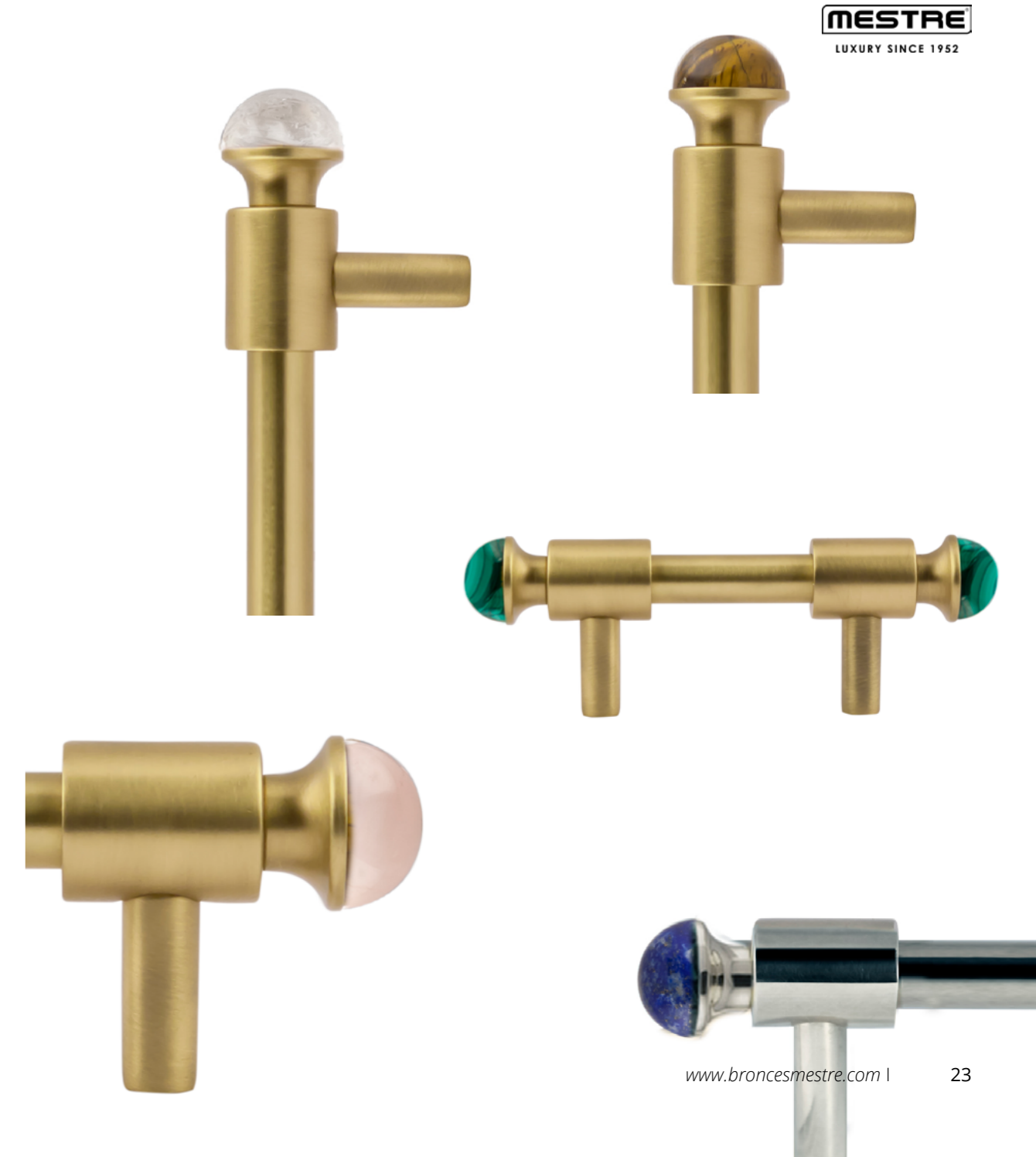

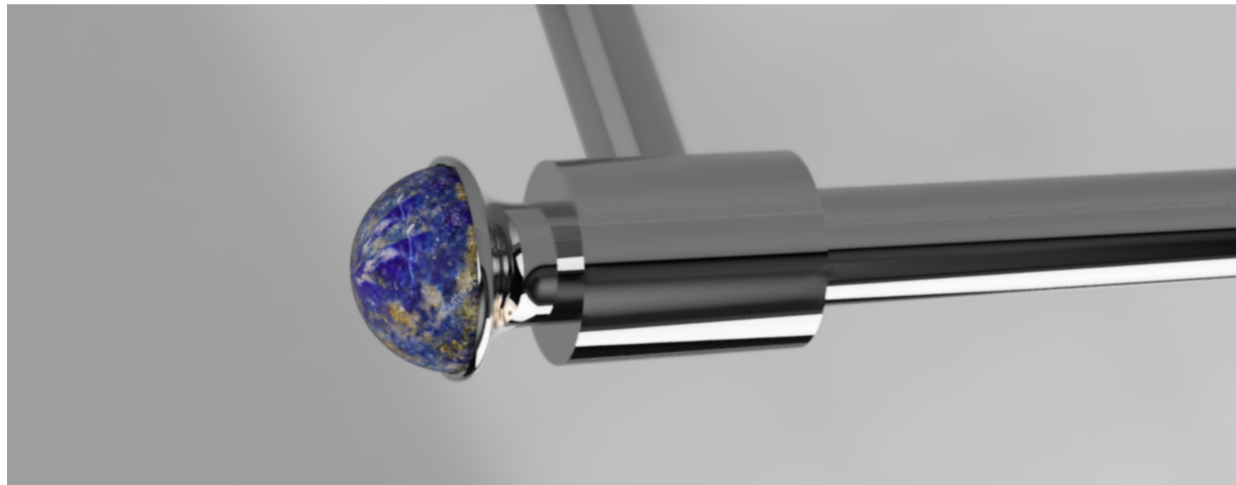



TIGER'S EYE GEMSTONE



MALACHITE GEMSTONE



192mm
OT5000.TG192.30



192mm
OT5000.ML192.30



160mm
OT5000.TG160.30



128mm
OT5000.TG128.30



96mm
OT5000.TG96.30



64mm
OT5000.TG64.30



160mm
OT5000.ML160.30



128mm
OT5000.ML128.30



96mm
OT5000.ML96.30



64mm
OT5000.ML64.30



CLEAR QUARTZ GEMSTONE



ROSÉ QUARTZ GEMSTONE



192mm

OT5000.QT192.30



192mm

OT5000.QTP192.30



160mm

OT5000.QT160.30



128mm

OT5000.QT128.30



96mm

OT5000.QT96.30



64mm

OT5000.QT64.30



160mm

OT5000.QTP160.30



128mm

OT5000.QTP128.30



96mm

OT5000.QTP96.30



64mm

OT5000.QTP64.30

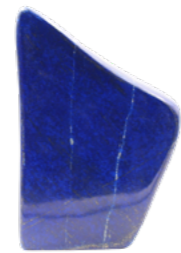

LAPIS LAZULI GEMSTONE



192mm
OT5000.LP192.30



160mm
OT5000.LP160.30



128mm
OT5000.LP128.30



96mm
OT5000.LP96.30



64mm
OT5000.LP64.30



WITH DECORATIVE
HANDICRAFT
DETAILS

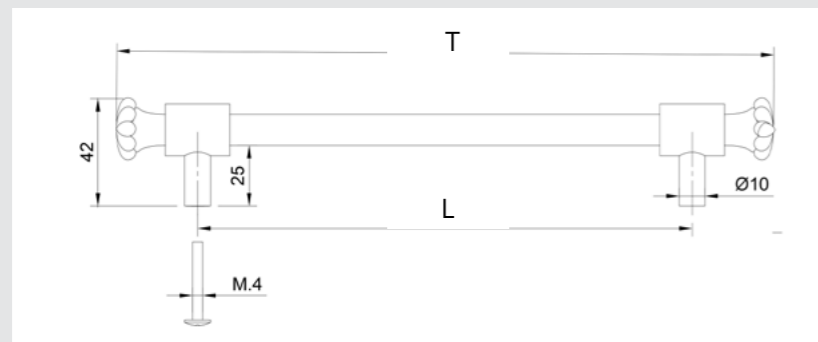

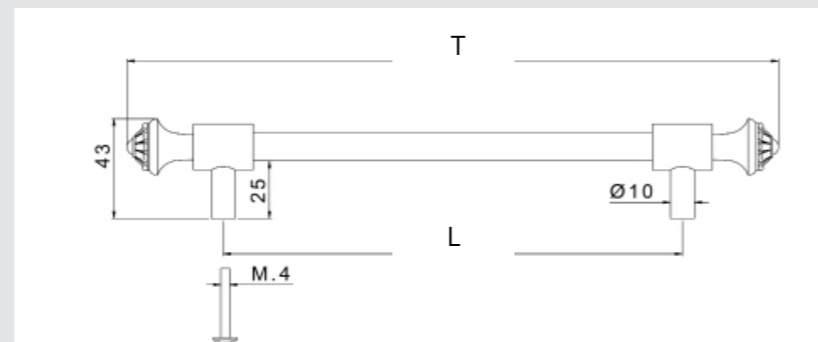

OT5033.***.** L = 192 160 128 96 64
T = 255 223 190 159 127

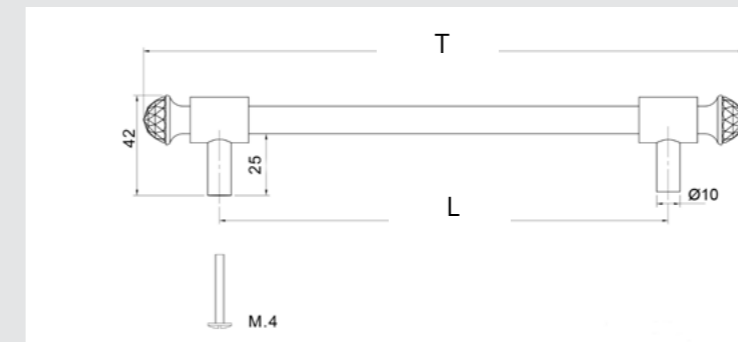

OT5033.APT***.** L = 192 160 128 96 64
T = 272 240 208 176 144

WITH DECORATIVE
SWAROVSKI CRYSTAL
DETAILS



-  OT5000.S192.**
-  OT5000.SN160.**

L = 192 160 128 96 64
T = 257 225 194 162 129

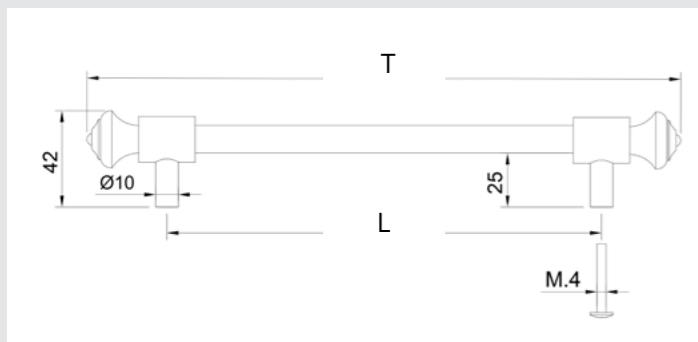

OT5036.***.** L = 192 160 128 96 64
T = 262 230 198 166 134

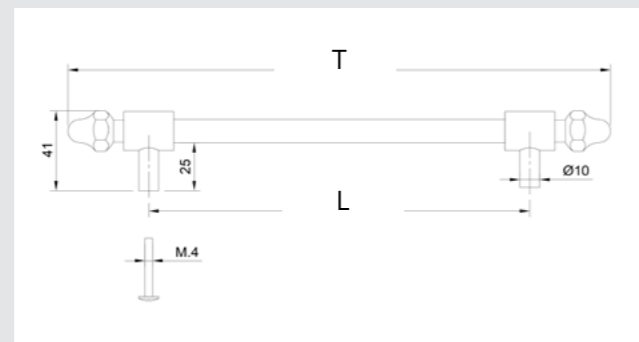

OT5035.***.** L = 192 160 128 96 64
T = 273 241 209 177 145

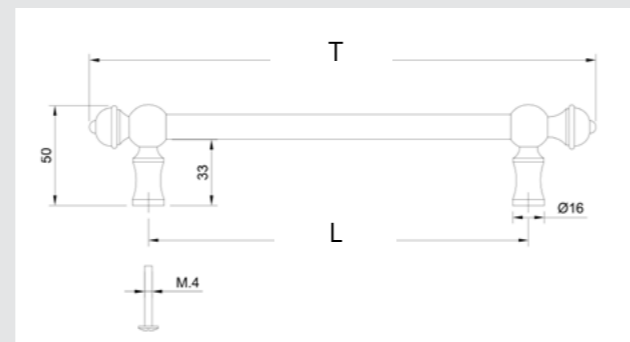

OT6442.***.** L = 192 160 128 96 64
T = 256 224 192 160 128

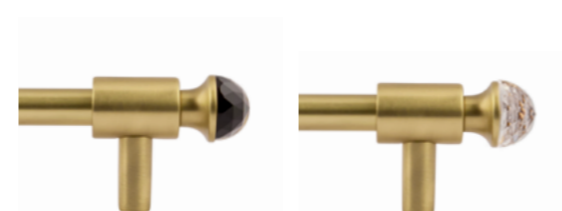

Technical information

WITH DECORATIVE
GEMSTONES
DETAILS

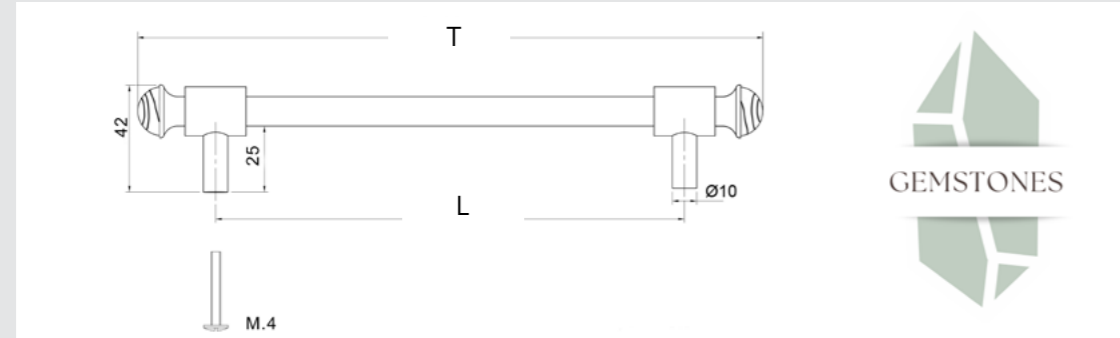

- OT5000.LP**.**
 - OT5000.TG**.**
 - OT5000.ML**.**
 - OT5000.QTP**.**
 - OT5000.QT**.**
- L = 192 160 128 96 64
T = 256 224 192 160 128



HANDICRAFT AND QUALITY
MADE IN SPAIN

Our main target is to achieve the highest quality and excellence in all of our products to make our clients dreams a wonderful reality and let them enjoy luxury interiors, embellished with our bathrooms fittings and decorative door hardware.

Mestre produces a rich selection of classical taps, elegant faucets and exclusive accessories for the bathrooms as well as all the accessories for door, furnitures and window as handles, knobs. Pure brass, Swarovski crystals and best finishes together with experience, know-how and handcrafted work are always essential.

The essence of our production philosophy is the constant research of the perfection. Every single piece has to shine like fine jewelry for the home. Our designs are classical and contemporary with elegant shapes and are made in Spain following the highest standards of quality

RECOMMENDED
FINISHES



01
24K Gold



30
Antique brass



50
Chrome



62
Satin Nickel

MATERIAL



Brass

Each unique masterpiece is handcrafted with brass.

LUXURY BATHROOM FITTINGS AND DOOR HARDWARE



www.broncesmestre.com